



Wrist Camera Vision System for CB-Series Universal Robots

Instruction Manual

Get the latest version of the manual at support.robotiq.com

Original Notice

Table of Contents

1. General Presentation	5
2. Safety	10
2.1. Warning	10
2.2. Intended Use	12
3. Installation	13
3.1. Scope of Delivery	14
3.1.1. Wrist Camera Kit for Universal Robots:	14
3.2. Required Tools and Equipment	15
3.3. Environmental and Operating Conditions	17
3.4. Mechanical Installation	18
3.4.1. Combo of 2-Finger Adaptive Gripper and Wrist Camera for Universal Robots	20
3.5. Electrical Setup	21
3.5.1. Pinout Interface	21
3.5.2. Power Supply	21
3.5.3. Cable Management	23
3.6. Software	23
3.6.1. Wrist Camera URCap Installation	24
3.6.1.1. Wrist Camera URCap Installation	24
3.6.2. Update and Uninstall	28
3.6.2.1. Version 1.1 and following	28
3.6.2.2. Version 1.0.2 and previous	30
4. Snapshot Position	31
4.1. Guidelines on Snapshot Position	33
4.2. Snapshot Position Wizard	34
4.3. Copy a Calibration	38
5. Object Teaching	39
5.1. Guidelines on Object Teaching	40
5.2. Teach Object Wizard	42
5.2.1. Automatic Method	44
5.2.1.1. Select Calibration	44
5.2.1.2. Select Model	45
5.2.1.3. Edit Model	56
5.2.1.4. Refine Model	61
5.2.1.5. Validate Model	62
5.2.1.6. Scan Model	63
5.2.2. Parametric Method	64
5.2.2.1. Circle	65
5.2.2.2. Ring	66
5.2.2.3. Rectangle	66
5.2.2.4. Square	67
5.2.3. Configure Model	68

5.2.3.1. Multiple objects detection	70
5.2.3.2. Color Validation	71
5.2.3.3. Detection thresholds and scores	76
5.2.3.4. Camera settings	81
5.2.3.5. Save location	81
6. Programming with the Camera Locate Node	82
6.1. Linear Move with Feature	85
6.2. object_location pose	85
6.3. Edit Detection Threshold and Object Location	89
6.4. Camera Locate node at a variable Snapshot position	90
7. Specifications	92
7.1. Mechanical Specifications of Wrist Camera	93
7.1.1. Center of Mass and Moment of Inertia	94
7.2. Electrical rating & performance of Wrist Camera	96
7.3. Vision System Specifications	97
8. Maintenance	101
9. Spare Parts, Kits and Accessories	102
10. Troubleshooting	103
10.1. LED status	104
11. Warranty and Patent	105
12. Contact	107
A. Harmonized Standards, Declarations and Certificates	DD
A1. Declaration of Incorporation	DD
A2. Ingress Protection Certificate	DE

Revisions

Robotiq may modify this product without notice, when necessary, due to product improvements, modifications or changes in specifications. If such modification is made, the manual will also be revised, see revision information. See the latest version of this manual online at: support.robotiq.com.

2018-09-10

Updated section 3, 5 and 6 according to the PolyScope version of the user (CB-Series vs. e-Series).

Updated section 5 and all pertaining subsections; major changes to the Teach object wizard (color validation layer masks, multiple object detection, e-Series support).

2018-05-01

Updated section 5 and all pertaining subsections; major changes to the Teach object wizard

2018-03-26

Updated Section 3.6.2 for Update and uninstall

2017-06-07

Updated Section 3.6 for URcap package installation procedure

Updated Section 4.2 for calibration process

Updated Sections 5.2, 5.2.1, 5.2.2, 5.2.3 for new and improved teaching methods.

Added Section 6.2 to use advanced programming with the vision system.

Updated technical specifications (Section 7.3).

Updated calibration board for UR5 and UR10 robots (Section 4)

2016-11-16

Updated specifications (section 6)

Updated installations instructions (section 4)

Added Troubleshooting instructions (section 9.1)

2016-08-26

First release

1. General Presentation

The terms "Camera" and "Wrist Camera" used in the following manual all refer to the Robotiq Wrist Camera, while the term "Vision" and "Vision System" used in the following manual all refer to the Robotiq Wrist Camera Vision System for Universal Robots.

The Vision System uses the Robotiq Wrist Camera and the Camera Locate software on Universal Robots to provide you with a simple object teaching interface.

The interface allows to set up the Vision System so it can recognize object locations and orientations automatically. The Vision System, using the Camera Locate feature, is only designed to locate one object at the time on a predefined workplane. It gets the object's position (x, y) and orientation along the z-axis. It allows to operate the robot according to the object location. The Camera is designed to work in industrial applications in combination with the Robotiq 2-Finger Adaptive Gripper.

Note

The following manual uses the metric system. Unless specified, **all dimensions are in millimeters.**

Note

The following section presents the key features of the Vision System and must not be considered as appropriate to complete operation, each feature is detailed in the appropriate section of the manual. Safety guidelines must be read and understood before any operation is attempted with the system.

Vision System components:

The figure below describes the various components of the Robotiq Vision System for Universal Robots. This system will use the Robotiq Wrist Camera, mounted on any of the Universal Robots (UR3, UR5, UR10) using a CB3.1 controller or greater. For a list of provided components with your Robotiq Wrist Camera kit for UR, please refer to the [Scope of Delivery section](#).

Caution

Robotiq Vision System is only compatible with Universal Robots with controller version CB3 and later, to identify your controller, please contact your Universal Robots representative.

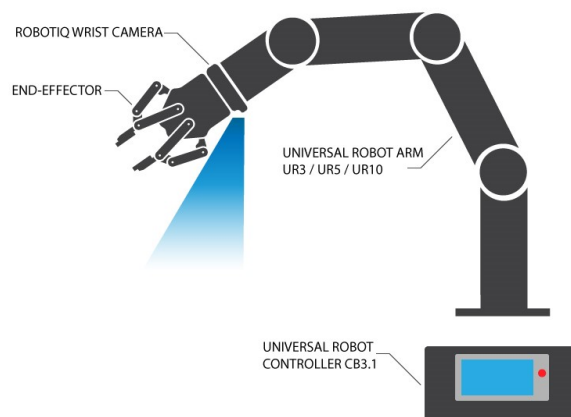

Fig. 1-1: Schematic representation of the Robotiq Wrist Camera Vision System hardware.

- Robotiq Wrist Camera: Described in details in sub-section Wrist Camera below.
- End effector: Any tool mounted on the robot for its application, the Wrist Camera is meant for direct integration of the Robotiq 2-Finger Adaptive Gripper.
- Universal Robot Arm: Any of the UR3, UR5 or UR10 model from Universal Robots.
- Universal Robot Controller: Controller model CB3 from Universal Robots.

Snapshot Position & Workspace

The figure below illustrates the various terms used in the following manual to describe the Vision System's Snapshot Position and workspace. The object location process will always start at the Snapshot Position, that position will determine the field of view of the Camera and thus the workspace. See the [Snapshot Position](#) section for details on how to teach the Snapshot Position.

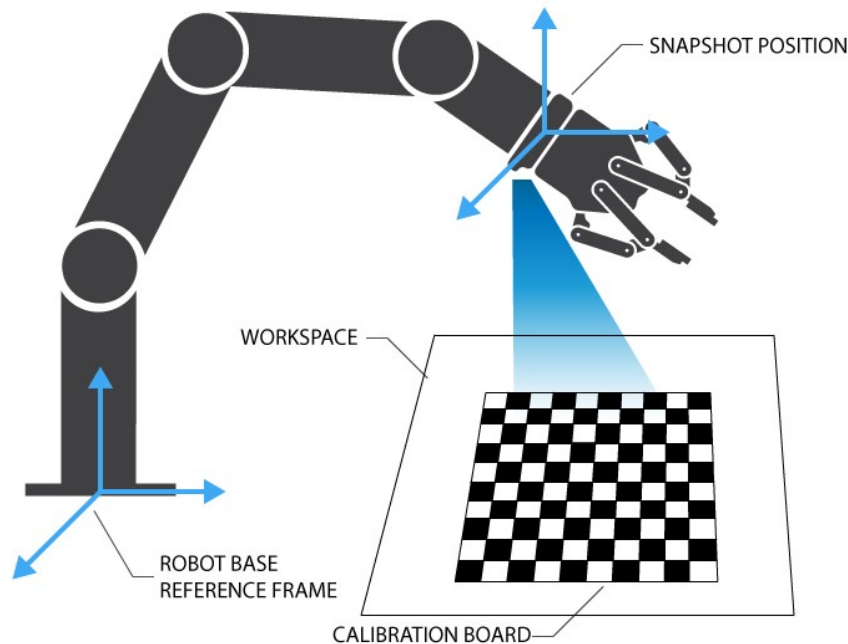

Fig. 1-2: Schematic representation of the Robotiq Vision System Snapshot Position and workspace concepts.

- Snapshot Position: the robot pose use to take snapshots from the Wrist Camera.
- Workspace: the area of interest for the Vision System, it is defined by the Camera's field of view.
- Object: the object you want to locate using the Vision System.
- Calibration board: a grid provided with your Camera UR Kit used during the calibration process of the Snapshot Position.

Object Location

The System will use the Camera Locate node described in the [Programming with the Camera Locate Node](#) section to locate the object. The figure below represents the object location process. Please refer to the [Programming with the Camera Locate Node](#) section for details on the object location process.

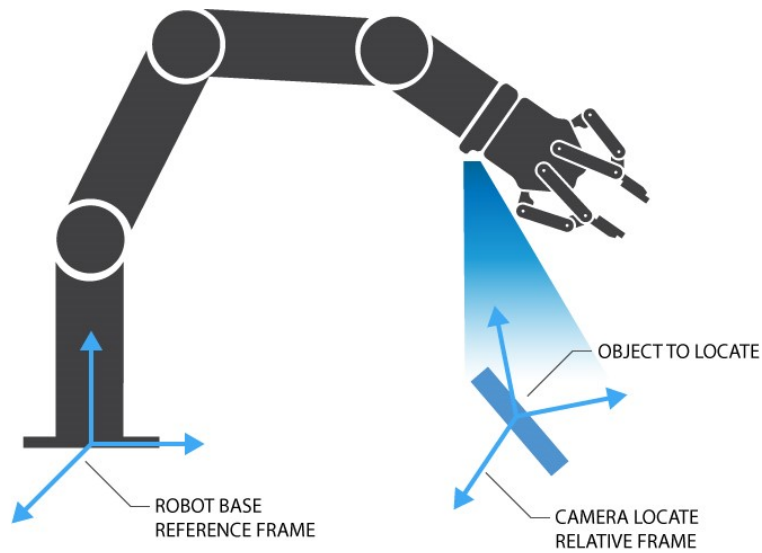

Fig. 1-3: Object location process schematic representation.

- Object to locate: The object you want to locate with coordinates X & Y and rotation Rz.
- Camera Locate relative frame: The reference frame updated by the Vision System to provide you with the object location.
- Robot base frame: The reference frame of the Universal Robot. Coordinate [0,0,0].

Wrist Camera

The hardware at the center of the Vision System is the Robotiq Wrist Camera illustrated in the figure below. Steps on how to install the Wrist Camera are explained in the [Installation](#) section.

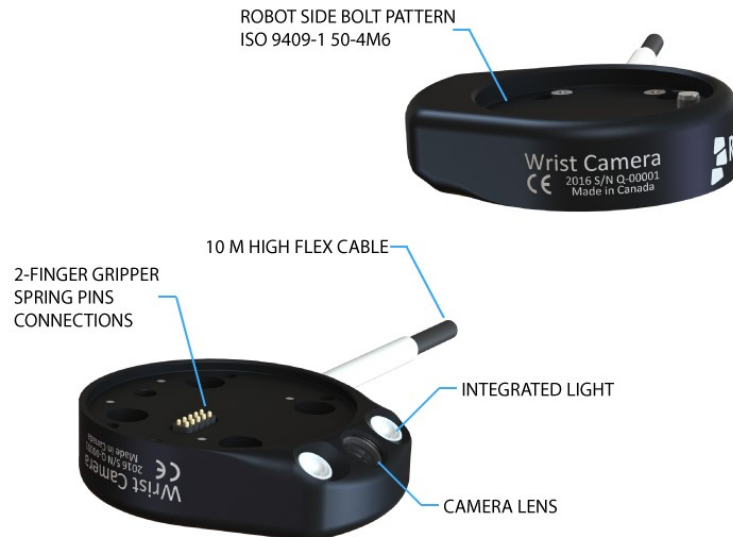

Fig. 1-4: Main features of the Wrist Camera.

Main features of the Robotiq Wrist Camera:

- CMOS image sensor with liquid lens:
 - Resolution: 0.3 to 5 Mpx;
 - Frame rate: 2 to 30 FPS;
 - Focus from 70 mm to infinity, automatic control.
- 2 sets of 3 LEDs:
 - Integrated lighting with automatic control.
- Single high-flex 10 meter pigtail cable:
 - USB 2.0;
 - 24V DC power.
- ISO 9409-1-50-4M6 bolt pattern, both sides:
 - Direct mounting on the UR;
 - Direct mounting of the 2-Finger Adaptive Gripper on the Camera.

Info

The Robotiq Wrist Camera provides a direct mounting interface for the Robotiq 2-Finger Adaptive Gripper, providing a mechanical interface, 24 V power and communication to the Gripper.

2. Safety

Warning

The operator must have read and understood all of the instructions in the following manual before handling the Robotiq Wrist Camera Vision System for Universal Robots.

The term "operator" refers to anyone responsible for any of the following operations on the Wrist Camera Vision System:

- Installation
- Control
- Maintenance
- Inspection
- Calibration
- Programming
- Decommissioning

This documentation explains the various components of the Vision System, as well as general operations regarding the whole life-cycle of the product from installation to operation and decommissioning.

The drawings and photos in this documentation are representative examples and differences may exist between them and the delivered product.

2.1. Warning

Note

Any use of the Vision System in noncompliance of these warnings is inappropriate and may cause injury or damage.

Warning

The Wrist Camera Vision System used in human-robot collaboration must not be considered a complete safety measure, additional dedicated safety device(s) must be considered. Vision System failure can occur and result in danger for workers or machinery if not properly secured. See local or international safety measure for human-robot collaboration.

Warning

- The Camera needs to be properly secured before operating the robot.
- Do not install or operate a Camera that is damaged or lacking parts.
- Never supply the Camera with an alternative current.
- Make sure all cord sets are always secured at both ends, at the Camera and at the robot.
- Always respect the recommended keying for electrical connections.
- Be sure no one is in the robot and/or Camera path before initializing the robot's routine.
- Always respect the Camera payload.
- All local safety measures and/or laws on robot operation must be applied to the Vision System.
- Avoid looking straight at the LEDs when they are turned on as this may cause dazzlement.

Any use of the Vision System in noncompliance with these warnings is inappropriate and may cause injury or damage.

2.2. Intended Use

The Vision System is designed to locate objects laying flat on the defined workspace. The system can identify and locate multiple kind of objects, each object will require its own object teaching process as explained in the [Object Teaching section](#). The Vision System gets the object's position (x, y) and orientation along the z axis. It allows to operate the robot according to the object location.

Tip

The [Guidelines on Snapshot Position section](#) will give you advice on what workspace should be used or avoided. Section 5 will give you advice on what objects can be located or not along with background recommendations.

Caution

The Vision System is NOT intended for:

- Metrology
- Bar-code / QR code reading

Note

Always comply with local and/or national laws, regulations and directives on automation safety and general machine safety.

The unit may be used only within the range of its technical specifications. Any other use of the product is deemed improper and unintended use. Robotiq will not be liable for any damages resulting from any improper or unintended use.

3. Installation

The following subsections will guide you through the installation and general setup of your Robotiq Wrist Camera Vision System:

- Section 3.1 details the scope of delivery for the Wrist Camera kit for UR, verify your package.
- Section 3.2 lists the required tools, parts and equipment for proper use of your Camera.
- Section 3.3 explains the operating conditions that must be met for the 2-Finger Gripper to operate normally.
- Section 3.4 guides you through the mechanical installation using the Wrist Camera and other optional parts.
- Section 3.5 describes the required electrical set up of the Gripper, its power source and cable management.
- Section 3.6 guides you through the software installation.

Warning

Before installing :

- Read and understand the safety instructions related to the Vision System.
- Verify your package according to the scope of delivery and your order.
- Have the required parts, equipment and tools listed in the requirements ready.

Warning

When installing :

- Meet the environmental conditions.
- Do not operate the Vision System, or even turn on the power supply, before the Camera is **firmly anchored and the danger zone is cleared**.

3.1. Scope of Delivery

3.1.1. Wrist Camera Kit for Universal Robots:

RWC-UR-KIT

Standard upon delivery:

- Robotiq Wrist Camera with 10m High-Flex pigtail cable **RWC-CAM-001**;
- Universal Robots pattern tool plate **RWC-TOOL-062**;
- 16 Gb USB stick **ACC-USB-16G**;
- USB software license dongle **ACC-USB-DONGLE**;
- 4-port USB hub **ACC-USB-4-HUB**;
- Calibration board **ACC-CALIB-BOARD**;
- Colored background for object teaching **ACC-TEACH-BACK**;
- Hardware kit for fixing Wrist Camera on Universal Robots.

Caution

The hardware for fixing a tool on the Wrist Camera is not provided.

Combo of 2-Finger Adaptive Gripper and Wrist Camera for Universal Robots:

CUR-AGC-085-RWC or CUR-AGC-140-RWC

Standard upon delivery:

- Wrist Camera Kit for Universal Robots includes:
 - **Robotiq Wrist Camera with 10m High-Flex pigtail cable RWC-CAM-001**;
 - 16 Gb USB stick **ACC-USB-16G**;
 - USB software license dongle **ACC-USB-DONGLE**;
 - 4-port USB hub **ACC-USB-4-HUB**;
 - Calibration board **ACC-CALIB-BOARD**;
 - Colored background for object teaching **ACC-TEACH-BACK**;
 - Hardware kit for fastening Wrist Camera to Universal Robots.
- Gripper parts:
 - Basic Gripper unit (85 or 140) **AGC-GRP-002** or **-140** (depending on your combo);
 - Screw kit for fixing Gripper on Wrist Camera.

3.2. Required Tools and Equipment

The following tools are required to install the Wrist Camera:

- 2 mm slotted screwdriver to perform terminal block connections when wiring.

Provided tools with the Wrist Camera:

- 4 mm hex key to mount the Camera on the UR arm.

Optional tools if installing 2-Finger combo: **CUR-AGC-085-RWC** or **CUR-AGC-140-RWC**:

- none, use the provided 4 mm hex key.

The following parts are required for setup:

- Universal Robots UR3, UR5 or UR10 along with its controller;

Warning

The system is only compatible with UR CB3.1 controller, check your controller version.

- Universal Robots' PolyScope version must be 3.5 or later in order to install the URCap.
- Power supply if not using Universal Robots controller supply (see below);
- Fuse, see information below.

The Camera needs to be supplied by a DC voltage source. This power supply is not included with the Camera kit for UR. Required power supply must match the Robotiq device. The following table shows the specifications with regards to the power supply required to operate the Camera and the optional Robotiq Gripper.

SPECIFICATION	VALUE
Output voltage	24 V DC \pm 10%
Output current	1 A
Overcurrent	Recommended power supply with internal protection, otherwise fusing is required. 2 A fuse at 25°C [77°F] ¹

Table 3 - 1: Robotiq Wrist Camera and 2-Finger power supply requirements.

Info

¹Suggested fuse is a: Phoenix Contact # 0916605 2 A thermal; use AWG #20 wiring.

Warning

If your power supply exceeds the specified regulation, over-voltage protection is required.

Robotiq recommends the use of the following power supplies:

- For the 1A output current: TDK-Lambda DPP Series, *100W Single Output DIN Rail Mount Power Supply: DPP30-24*.

3.3. Environmental and Operating Conditions

The Wrist Camera is designed for industrial applications. Always respect the following specified operating environmental conditions:

CONDITION	VALUE
Minimum storage/transit temperature	-30°C [-22°F]
Maximum storage/transit temperature	70°C [158°F]
Minimum operating temperature	0°C [32°F]
Maximum operating temperature	50°C [122°F]
Humidity (non-condensing)	Non-condensing.
Others	Lenses must be free from dust, soot and water. Environment must be free from powerful electromagnetic interference. Environment must be free from corrosive or explosive liquids or gases.

Table 3 - 2: Environmental and operating conditions for the Wrist Camera.

3.4. Mechanical Installation

Wrist Camera kit for Universal Robots

For mechanical installation of a Wrist Camera on a UR robot along with an end-effector (other than Robotiq's 2-Finger Gripper), follow these instructions and refer to the figure below:

- Place the Wrist Camera (RWC-CAM-001) on the robot arm. Align the camera's indexing (dowel) pin properly in Universal Robots' bolt pattern.
- Place the tool plate (RWC-TOOL-062) on the camera. Align the tool plate's indexing (dowel) pin correctly in the Wrist Camera.
- Fix the desired end-effector on the robot arm, through the tool plate and the camera, using M6 screws.
- Fix the cable along the robot arm, please refer to the [Cable Management section](#).

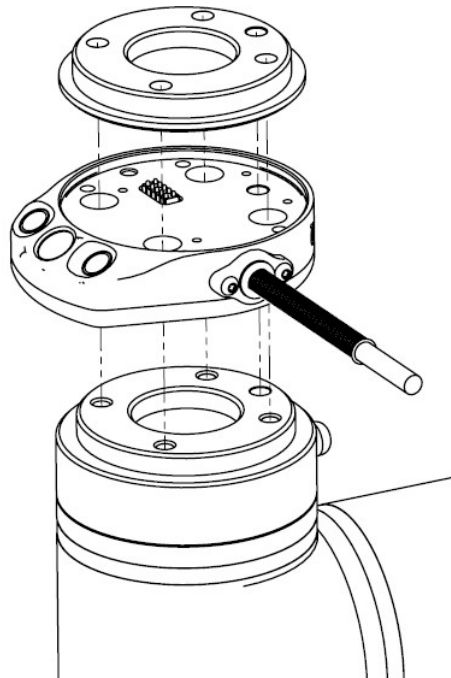

Fig. 3-1: Mechanical installation of the Wrist Camera kit for Universal Robots.

The end-effector is not screwed in the camera or the tool plate, but directly in the robot arm. Both camera and tool plate have through holes for this assembly.

Warning

Make sure the Camera is oriented properly.

Do not offset the Camera from the tool center point **on the X and Y axes**, or **around the Z axis**.

Hardware

M6 screws to mount an end-effector on the Wrist Camera are not provided. Use M6 screws of appropriate length to secure the end-effector on the robot arm.

3.4.1. Combo of 2-Finger Adaptive Gripper and Wrist Camera for Universal Robots

For mechanical installation of a Wrist Camera on a UR robot along with Robotiq's 2-Finger Gripper, follow these instructions, and refer to the figure below:

- Place the Wrist Camera (RWC-CAM-001) on the robot arm. Align the camera's indexing (dowel) pin properly in Universal Robots' bolt pattern.
- Fix the camera on the robot arm using the provided M6 X 12 LHCS screws and lock washers.

When mounting only the Wrist Camera on the robot, the spring pins that would ensure connection to a Robotiq 2-Finger Gripper are exposed. Be careful not to harm them.

- Mount the gripper directly on the Wrist Camera using the provided M5 X 35 SHCS and lock washers.
- Fix the cable along the robot arm; please refer to the [Cable Management](#) section.

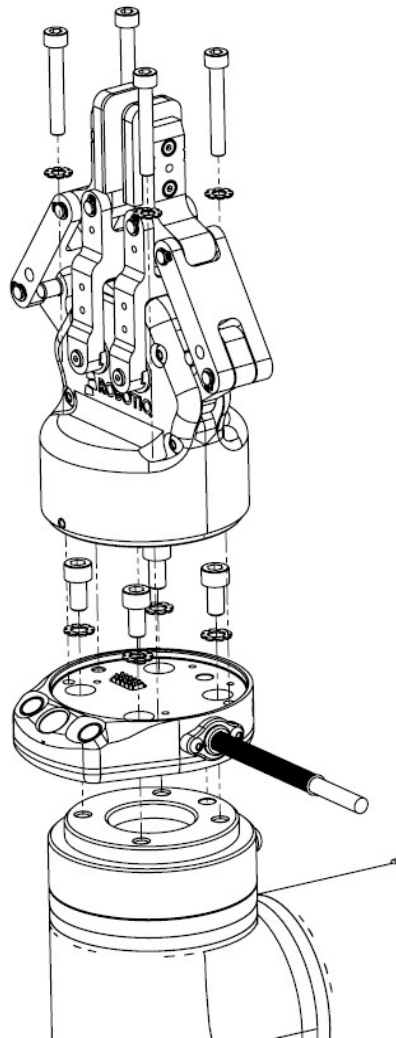
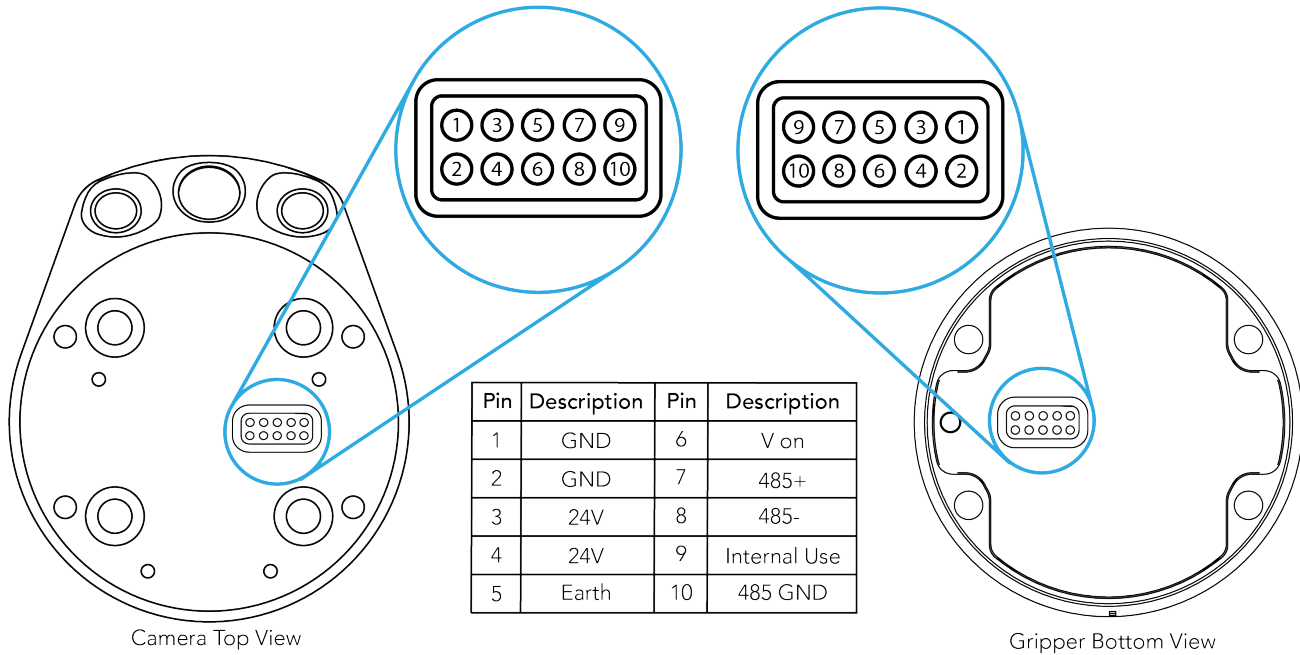

Fig. 3-2: Mechanical installation of the Combo of 2-Finger Gripper and Wrist Camera for Universal Robots.

3.5. Electrical Setup

3.5.1. Pinout Interface

The Wrist Camera interfaces with an end-effector (such as a Robotiq 2-Finger Gripper) via a 10-spring pin connector located on its outer surface.



3.5.2. Power Supply

Caution

If mounting a 2-Finger Gripper on the Wrist Camera, the Camera replaces the gripper's coupling. Therefore, only the Wrist Camera's device cable is required to provide power and communication to both the camera and the gripper. The wiring for setups including only the camera or both the camera and the gripper is the same.

Power and communication are established with the Wrist Camera via the high-flex device cable. The cable provides a 24V power supply to the Wrist Camera and enables USB 2.0 communication with the Universal Robots controller.

Follow these steps to correctly wire the Wrist Camera (or the camera and 2-Finger Gripper combo) to a Universal Robots controller :

- With the controller turned off, connect the red (24V) and black (0V) wires of the device cable as shown in the figure below. Use any available 24V and 0V.

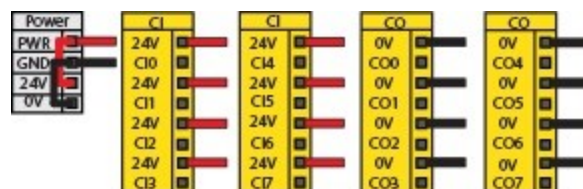

Fig. 3-3: Power supply wiring on CB3.1 Universal Robots controller.

- Connect the 4-port USB hub (ACC-USB-4-HUB) inside the robot controller.
- Connect the Wrist Camera's USB connector in the 4-port USB hub.
- Connect the license USB dongle (ACC-USB-DONGLE) in the 4-port USB hub.

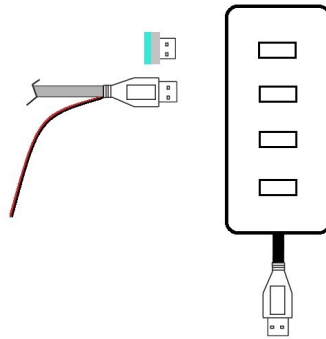

Fig. 3-4: 4-port USB hub connection.

Wrist Camera grounding is optional and is done via the robot ground. The camera's indexing pin (dowel) is the ground connector.

3.5.3. Cable Management

Warning

Use proper cabling management. Be sure to have enough forgiveness in the cabling to allow movement of the Gripper along all axes without pulling out the connectors. Always protect the controller side of the cable connection with a strain relief cable clamp.

3.6. Software

Make sure the Wrist Camera is properly mounted on the robot arm and that all electrical wiring is correctly done (refer to the [Mechanical Installation section](#) and the [Electrical Setup section](#)). Make sure your Universal Robots software is up to date. PolyScope must be version 3.3 or later in order to install a URCap.

- Refer to the [Wrist Camera URCap Installation section](#) for the installation procedure.
- Refer to the [Update and Uninstall section](#) to update the version or uninstall.

Do not unplug the 16 Gb USB stick or the USB license dongle, even after the installation has been completed.

Center of mass

Prior to use over Universal Robots, adjust the center of mass and payload from the Installation tab (refer to the [Mechanical Specifications of Wrist Camera section](#)).

3.6.1. Wrist Camera URCap Installation

Make sure the Wrist Camera is properly mounted to the robot arm and that all electrical wiring is correctly done (refer to the [Mechanical Installation section](#) and the [Electrical Setup section](#)). Make sure your Universal Robots software is up to date. The URCap pertaining to this product version has been tested in PolyScope 3.5.

Update

For the URCap update, refer to the [Update and Uninstall section](#).

3.6.1.1. Wrist Camera URCap Installation

- From support.robotiq.com, visit the vision system page and download the latest UCC-X.X.X compressed file.
- Decompress the content of the latest UCC-X.X.X compressed file on the provided 16 Gb USB stick (ACC-USB-16G).
- Make sure the .urcap file and the vision system folder are on the root of the USB drive, as shown in the figure below.

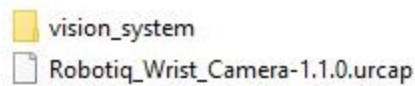

Fig. 3-5: Files at the root of the 16 Gb USB stick.

- With the robot controller ON, insert the 16 Gb USB stick containing the latest URCap and vision server in the 4-port USB hub.

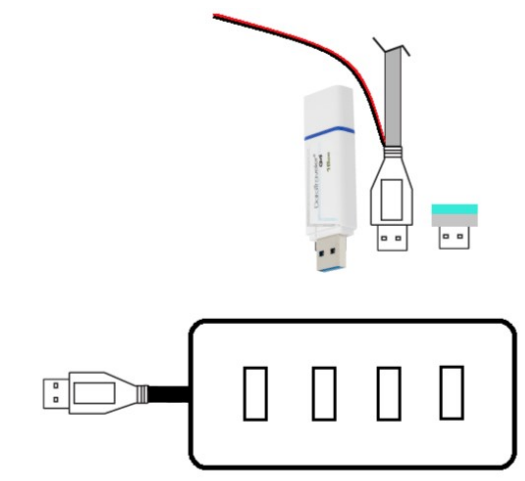

Fig. 3-6: Connections on the 4-port USB hub.

PolyScope 3.6+

- From PolyScope's home page, tap **Setup Robot** and go to **URCaps Setup**.
- Tap the plus (+) sign and open **Robotiq_Wrist_Camera-XXX.urcap** from the USB stick.
- Tap **Restart** and wait for PolyScope to reopen.
- Go to **Program Robot** and then to the **Installation tab**.
- Choose **Camera** and go to the **Dashboard tab**.
- Verify the Vision system's status.

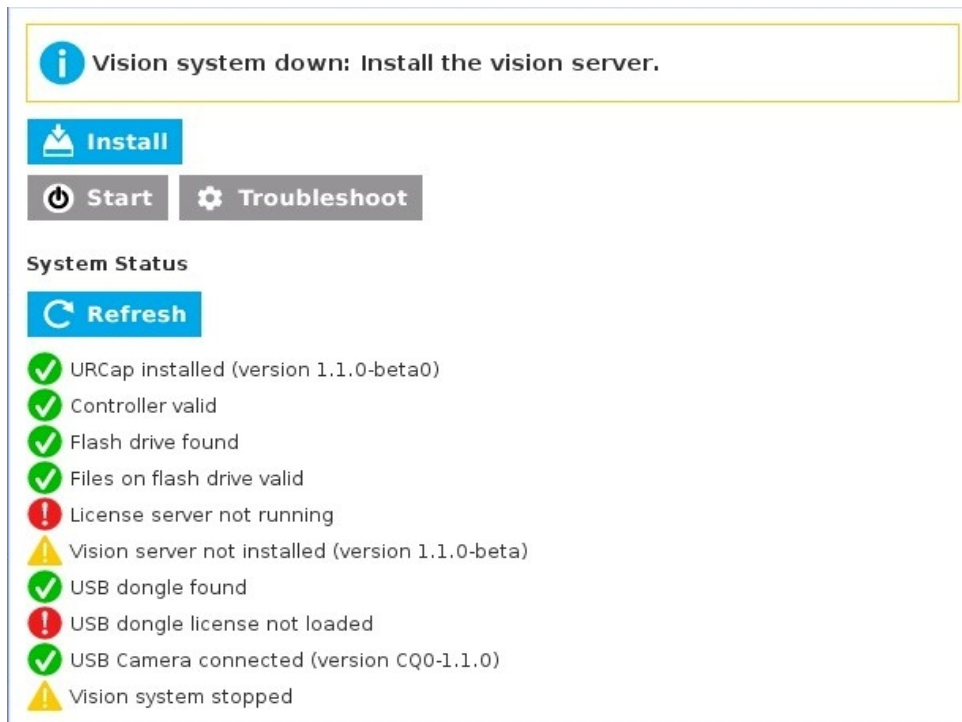

Fig. 3-7: Camera dashboard ready to install the vision server.

- Tap **Install** and wait for the vision server to be installed.
- If the firmware has to be updated, tap **Upgrade Camera firmware** to upgrade it before continuing (refer to the figure below).

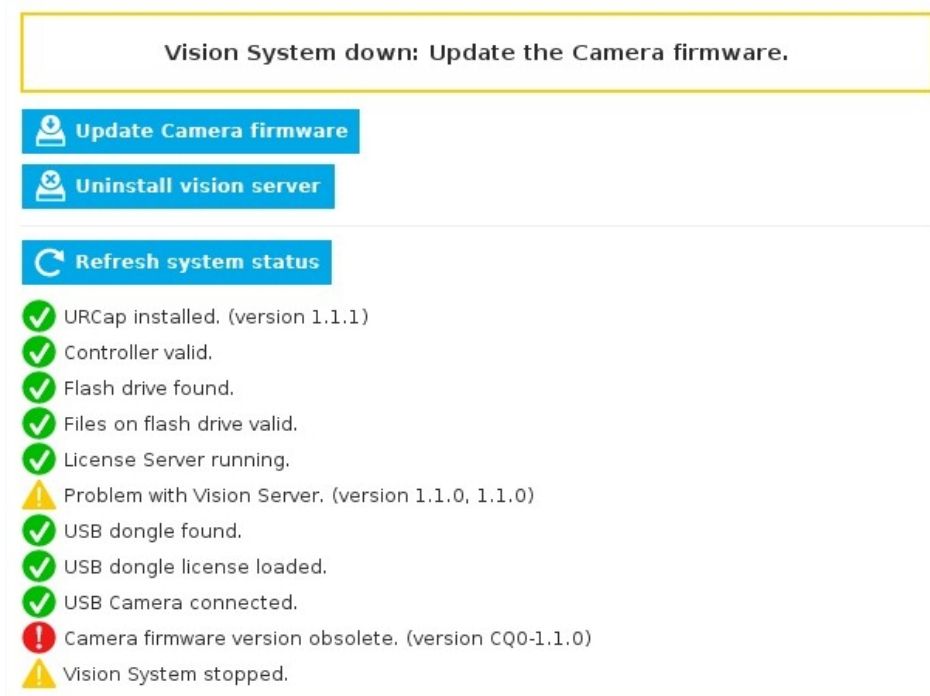

Fig. 3-8: Camera dashboard with camera firmware upgrade.

- Wait for the vision system to start.
- The installation is completed.
- In order to use another USB drive on the controller, reboot the robot controller.

Do not unplug the 16 Gb USB stick or the USB license dongle, even after the installation has been completed.

Dashboard

The Dashboard tab contains helpful information for troubleshooting the vision system.

Test the Installation

After the installation has been completed, verify that the vision system works properly.

PolyScope 3.6+

1. From a robot program, go to the **Installation** tab and choose **Camera**.
2. Go to the **Dashboard** tab and verify the system's status. Make sure the vision system is running.
3. Go to the **Camera** tab. The output image will appear.

Center of Mass

Prior to use over Universal Robots, adjust the center of mass and payload from the Installation tab (refer to the [Mechanical Specifications of Wrist Camera](#) section).

3.6.2. Update and Uninstall

Warning

Updating the Wrist Camera software, unplugging the USB storage device and/or switching USB ports must **always** be done while the robot is initialized and running.

3.6.2.1. Version 1.1 and following

PolyScope 3.6+

1. From a robot program, go to the **Installation** tab.
2. Tap on **Camera** and go to **Dashboard**.
3. Tap **Stop camera**.
4. Tap **Uninstall**.
5. Remove the 16 Gb USB stick containing the older URCap and vision server from the 4-port USB hub.
6. Go to **Setup Robot**.
7. Tap **URCaps Setup**.
8. In the Active URCaps text box, tap the Camera URCap.
9. The Camera URCap should be highlighted.
10. Tap the minus button (-) to uninstall the URCap.
11. **Restart** PolyScope to complete the uninstall process.
12. Turn off or reboot the controller.
13. Connect the 16 Gb USB stick containing the older URCap and vision server to a PC.
14. Format it using FAT32.
15. Follow the procedure from the [Wrist Camera URCap Installation section](#) to install the newest software.

3.6.2.2. Version 1.0.2 and previous

1. On a blank USB stick, add the following file : `urmagic_uninstall.sh` .
2. From a **Robot Program**, go to the **Installation** tab. Choose **Camera** and go to the **Camera** tab.
3. Tap **Stop camera** to stop the Vision server.
4. With the controller on, insert the USB stick containing the `urmagic` file in the UR teach pendant. Automatic uninstall will begin.
5. Wait for the uninstall to be completed. Remove the USB stick containing the `urmagic` file.
6. Remove the 16 Gb USB stick containing the vision server.
7. From the home page, go to **Setup Robot**.
8. Tap **URCaps Setup**.
9. In the Active URCaps text box, tap the Camera URCap.
10. The Camera URCap should be highlighted.
11. Tap the minus button (-) to uninstall the URCap.
12. Turn off or reboot the controller
13. Connect the 16 Gb USB stick to a PC.
14. Format it using FAT32.
15. Follow the procedure from the [Wrist Camera URCap Installation section](#) to install the latest software.

4. Snapshot Position

Prior to teaching object with the Camera Locate URCaps node (refer to the [Programming with the Camera Locate Node section](#)), the operator must define a Snapshot Position using the Snapshot Position wizard. The following section and sub-sections will guide you through this process.

Requirements:

- You must have completed the installation steps of the [Installation section](#).
- Robot must set up to reach the desired workspace.
- You must have the correct calibration board in hand.

Reminders:

- You can teach as many Snapshot Positions as you want.
- Snapshot Position is where the robot is positioned to search for objects.
- One Snapshot Position can be used to search many objects.
- When the object teaching process of the [Object Teaching section](#) is done, it is linked to the Snapshot Position and you cannot change that position.
- Each Snapshot Position along with the workplane will define a workspace according to the field of view of the Camera. Refer to the [Specifications section](#) for details on the field of view.

Calibration Boards:

Tip

If you are viewing a printed version of this manual, please visit support.robotiq.com to download the file.

- For UR5 and UR10

Along with your kit you will have the calibration board used for UR5 and UR10 on one side of the board, part number **ACC-CALIB-BOARD**.

If you lose or damage your board, you can print the following file:

Note

If you are viewing the PDF version of the manual, please visit the online version of this manual at support.robotiq.com to get the calibration board files. If you have printed this manual, please stop doing so, save some trees and visit the website.

Info

UR5 and UR10 calibration board must be printed on Letter (11" x 17") or A3 paper, make sure scale is at 100%. You can validate that your calibration board had the good scale by measuring the scale on your sheet.

- For UR3

Along with your kit you will have the calibration board used for UR3 robots on one side the the board, part number **ACC-CALIB-BOARD**. The color balance circles are not used yet with the vision system and are for future use. If you loose or damage your board, you can print the following file:

Info

UR3 calibration board must be printed on Letter (8.5" x 11") or A4 paper, make sure scale is at 100%. You can validate that your calibration board had the good scale by measuring the scale on your sheet.

4.1. Guidelines on Snapshot Position

Caution

During the snapshot position definition, the ambient light must be of approximately 500 lux. At run-time, this condition is not required.

The following must be considered when choosing your Snapshot Position:

- Choosing the workspace:
 - Mostly uniform color;
 - Planar;
 - Provide contrast to your part; refer to the [Vision System Specifications section](#) for details.
- Distance to the workplane:
 - Your Snapshot Position will determine the field of view of the camera and thus the workspace used afterwards.
 - See specifications in the [Vision System Specifications section](#) for details on the field of view & part size;
 - Getting closer to the workplane, will reduce your workspace but allow you to locate smaller objects;
 - Getting away from the workplace will increase the workspace but will increase the minimum size of objects to locate.

Tip

During the Snapshot Position define step, use the "Show Grid" button, a grid will appear. Your object should be larger than one grid cell.

- Angle of the camera:
 - Snapshot position should consider the Camera angle:
 - Robotiq greatly recommends to have the Camera perpendicular to the surface:
 - Be as close as possible to perpendicular, avoid reflections.
 - Object should be seen from the top view, not from the side.
- Calibration board:
 - Snapshot position does not need to see the full calibration board, calibration step does.

Tip

The Snapshot position and Calibration pose are decoupled, they do not need to be the same.

- Use the appropriate calibration board.
- Board must be fully visible by the Camera.
- Refer to the [Vision System Specifications section](#) for Calibration board position specifications.

4.2. Snapshot Position Wizard

Feature Point:

Prior to defining the Snapshot Position, the operator must define a feature point. To do so, from the Universal Robots Polyscope interface:

- Start a new program or open yours, then go to the **Installation** tab.
- Go to **Features**.
- Tap **Point** to insert a new point feature.
- Select that point, check the **Variable** checkbox.
- Define that point position anywhere by tapping **Set this waypoint**, then tap **OK**, actual position does not matter.
- Tap **Rename** to give a significant name to your feature, that name will be used as a reference frame later on in your program.

Info

Each Snapshot Position you teach will require its own Feature point.

Snapshot Position Wizard:

Snapshot Position is defined using the Snapshot Position Wizard, from the Universal Robots Polyscope interface, still within the Installation tab:

- Go to **Camera**.
- Go to the **Snapshot Positions** tab.
- In the drop-down list, select the **Feature** you wish to use.
- Tap **Define** to launch the wizard.

Wizard step 1: Define Snapshot Position

- Move the robot arm using the **Freedrive** to place the Wrist Camera.
 - Remember the guidelines from the [Guidelines on Snapshot Position](#) section:
 - Distance will determine field of view and size of objects to be located.
 - Use the Show Grid to help you choose distance (object at least one cell).
 - Camera view should be quasi perpendicular to surface.
- Once the robot arm is in a proper position, tap **Save position**. Wizard will go to next step.

Wizard step 2: Calibrate

- Place the appropriate calibration board in the field of view of the camera
 - Remember to use the appropriate board, according to your robot model
 - The board orientation should match the screen - landscape orientation

- Make sure the Camera see the whole board

Tip

Snapshot Position will determine the field of view, notice that the calibration step position does not have to be the same as Snapshot position. Thus, you can have a small field of view, then move back for calibration step.

- Tap **Calibrate** to begin calibration

Warning

Calibration is an automatic process, the robot will move in order to perform calibration. Make sure the robot workspace is clear. You can tap Cancel to stop the process. Operator should watch the robot at all time and have emergency stop button at hand.

- The Vision System will center on the board and take 27 poses of the board.
- After the 27 poses, it will take 9 more photos for validating.
- When the process is done, you will be asked to **Accept** or **Re-Calibrate**.
 - **Accept** if the calibration board grid is match on all pose (first 27 poses)
 - **Re-Calibrate** if the grid is not matched
- The wizard will show the 9 validating poses.
- Verify that the accuracy on the validation poses according to the color chart.
 - Dark blue: local accuracy of +/-0mm.
 - Dark red: local accuracy of +/-4mm and over.

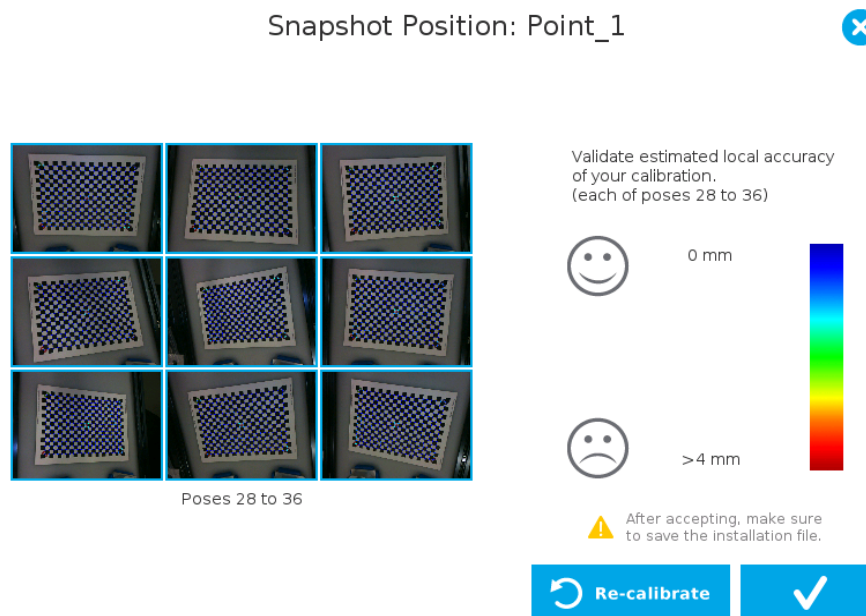

Fig. 4-1: Validating poses.









- If the accuracy is larger than +/- 4mm, an message will inform you that you should perform the calibration again.
- When you tap **Accept**, you will exit the wizard and the process is completed.

Once the calibration has been accepted, the Snapshot Position will appear in the Snapshot Positions tab with the name of the Feature Point previously created. You can define other Snapshot positions, as long as you define new Feature Points. To delete a Snapshot Position, tap the bin.

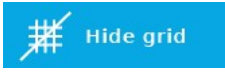
Tip

Make sure you save the Installation file (tap **Load/Save** from the Installation tab) in order to save the Snapshot positions created.

Features

Icon	Feature	Description
	Define	Launches the Snapshot Position definition wizard.
	Show grid	Displays a grid on the camera's field of view. Meant to test the camera's height relative to the workplane : a part should be at least as large as a square of the grid.
	Hide grid	Hides the grid of the camera's field of view.
	Save position	Saves the robot position for the Snapshot Position. This is the position from which the robot will do the part detection.
	Calibrate	Starts the calibration procedure. The robot will move automatically to defined positions for the calibration.
	Cancel	Cancels the calibration procedure while it is running.
	Re-calibrate	Restarts the calibration procedure.
	Accept	Accepts the calibration process.
	Delete	Deletes a defined Snapshot position.

4.3. Copy a Calibration

When defining a snapshot position, it is possible to copy the calibration from another snapshot position. This allows for a faster snapshot position modification when using the same work plane.

Work Plane

To ensure proper precision, the work plane surface of both (new and copied) snapshot positions should be the same.

To copy a calibration, you need to have a snapshot position already defined from which you want to copy the calibration.

- Create a new Snapshot feature point on the same plane as the existing Snapshot point you want to copy.
- Move the robot to this position.
- Go to the **Installation** tab, select **Camera** from the menu on the left and tap the **Snapshot** tab
- Choose the new Snapshot position.
- Select the existing Snapshot position you want to copy and select **Copy**.
- In the Wizard, select **Save This Position**.
- The calibration from the previously selected snapshot position will be used for this new one.

5. Object Teaching

Once the snapshot position is defined (see section 4), the operator can use the Camera Locate node within a Universal Robot program to teach an object to locate. The following section and sub-sections will guide you through this process.

Requirements

- You must have completed the installation steps of section 3.
- Snapshot position is defined as per steps of section 4.
- Have the object to teach in hand:
 - Have a few samples to test during the last step of the object teaching process.

Reminder

- A Camera Locate node will be used for a single model.
- Object teaching is linked to the snapshot position, if you want to change snapshot position, you will have to perform the object teaching again.
- You can teach many objects; each one will use a Camera Locate node.

Background

- Have a background that provides a maximum of contrast with your object, see section 4.1 for guidelines.

Tip

A colored background is provided with the camera kit. Use either the yellow or pink side to ensure a good color contrast with the object.

5.1. Guidelines on Object Teaching

Info

During the object teaching, the ambient light must be approximately 500 lux, and stable. At runtime, this condition is not required.

The following must be considered when going through the object teaching process :

- Objects criteria for reliable localization:
 - Object is quasi-flat, respecting a maximum ratio of 1:1 between its height and its smallest dimension; please refer to the [Vision System Specifications section](#) for more details.
 - Top surface is mostly flat.
 - Object has a distinctive shape and distinctive features.

Info

Distinctive shape would mean an object contour that displays a sharp contrast with the background, and that is ideally not symmetric. Distinctive features are shapes present within the contour of the object that the vision system will be able to identify, such as holes, drawings, color contrasts, etc.

- Object is not highly reflective
- Object is not transparent

Tip

When teaching reflective objects, the user can turn the LEDs OFF to avoid bright spots contrasting with the actual color of the object.

- Choosing the appropriate background:
 - Workplane around the object must be planar, mostly uniform and clear of any other objects.
 - At runtime, the work space conditions can change, the object detection threshold can be used to adjust detection settings according to those conditions; refer to the [Detection thresholds and scores section](#) for details.
 - The background around the object must be a uniform, continuous shape with a single color.

Caution

From the vision system's point of view, white, gray and black are all gradients of gray. Avoid using a black background to teach metal objects. The model would be a pale gray object on a dark gray background and would therefore result in errors.

The Machine edge view feature shows edges seen by the camera in greyscale format. Please refer to the [Teach Object Wizard](#) section for more details. Refer to the [Vision System Specifications](#) section for specifications on color contrast.

Tip

At runtime, make sure you have the simplest and most uniform background possible for your application. Also have as few objects and object types as possible. This will decrease the cycle time.

Tip

The ambient light should be diffuse. Avoid high light intensity spots on your background. This will result in a faster object detection by the Wrist Camera and a lesser risk of false detection.

5.2. Teach Object Wizard

Camera Locate Node

To insert a Camera Locate node in the robot program, from the Universal Robots PolyScope interface:

- Start a new program or open yours, then go to the **Program** tab.
- Select the **Structure** tab.
- Go to the **URCaps** tab and tap **Cam Locate** to insert the node inside your program.

Teach Object Wizard

Info

Snapshot position must be defined to launch the object teaching wizard. If not, go to section 4.

The Teach object wizard will guide you through the process of teaching an object for locating with the camera. Select the **Cam Locate** node, go to the **Command** and tap **Teach object** to launch the wizard.

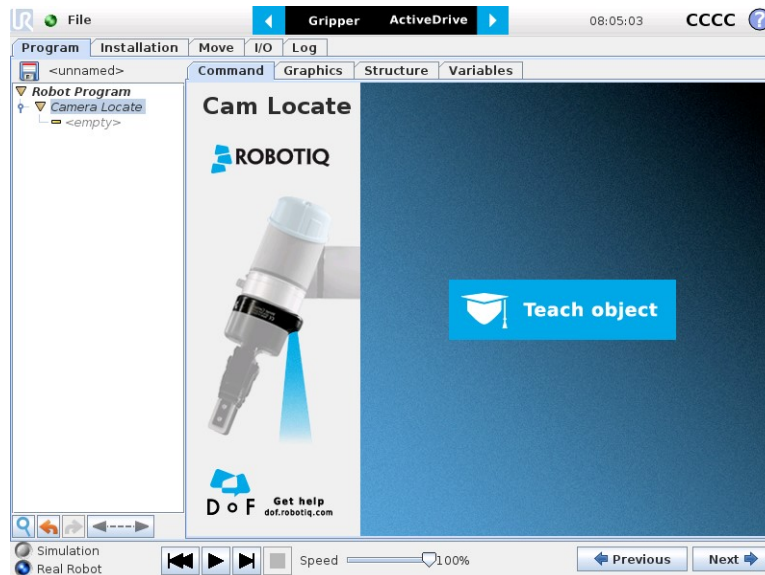

Fig. 5-1: Launch the object teaching wizard.

Choose teaching method

The first step is to choose the teaching method. Choose between either the automatic or parametric method:

- **Automatic method:** builds a model based on photos and a scan of the object. Best for complex and irregular shapes. Use this method if the object orientation has to be detected with one of its features. Please refer to the [Automatic Method section](#) for more details.
- **Parametric method:** builds a model based on parameters of a basic 2D shape (circle, ring, square or rectangle). This method is faster and allows the vision system to recognize and locate with high robustness objects that have few distinctive features such as raw material blanks. Usually gives best results than the Automatic method for simple geometry and highly reflective objects. Please refer to the [Parametric Method section](#) for more details.

Tip

At any moment during the teaching process, the user can access contextual help videos with the **Play** button.



Play button that displays contextual help videos for visual support in going through the teaching steps



Question mark button that displays an HTML version of the Wrist Camera's instruction manual directly on the teach pendant **(feature to be implemented in the near future)**



Select Teach Method



Choose a teaching method:



Automatic method
 Let the camera scan your object
Best for complex and irregular shapes

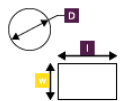

Parametric method
 Input the dimensions of a 2D basic shape yourself
Best for blanks or simple shapes

Fig. 5-2: Selection of the teaching method.

5.2.1. Automatic Method

Caution

A Snapshot position must be defined to launch the object teaching wizard. If no Snapshot position has been defined, please refer to the [Snapshot Position section](#).

5.2.1.1. Select Calibration

Tip

At any moment during the teaching process, the user can access contextual help videos with the **Play** button.

Tap the **Snapshot position** you want to use.

Info

If the robot is not at the Snapshot position, you will be prompted to move to the position. Tap and hold the **Move** button to do so.

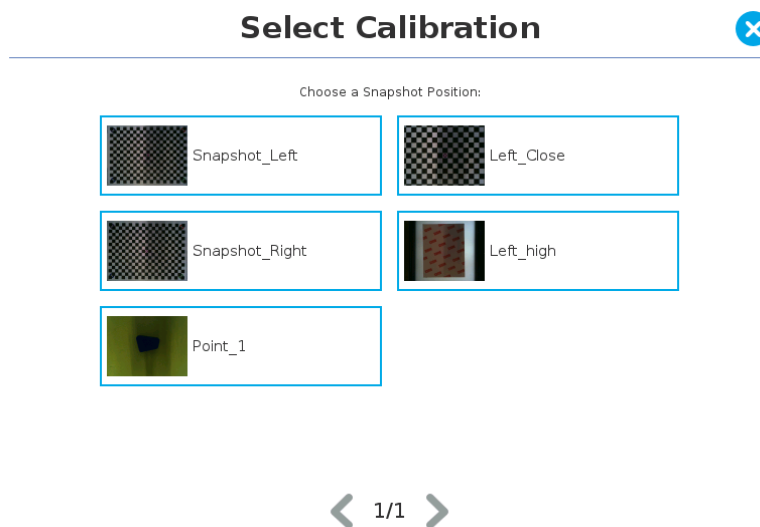

Fig. 5-3: Select Calibration step

5.2.1.2. Select Model

Tip

At any moment during the teaching process, the user can access contextual help videos with the **Play** button.

Prior to selecting a model, the user will place a background on the workplane and then position the object on the background. By default, the **Select Model** step displays the object to teach, automatically selected by the software, meaning a green selection rectangle overlaps the shape of the object.



Magic Wand tool; please refer to the [Automatic area selection section](#) for more details.



Tap and drag tool; please refer to the [Manual area selection section](#) for more details.



Zoom in button; please refer to the [Zoom in section](#) for more details.



Zoom out button; please refer to the [Zoom out section](#) for more details.



Accept model button for finalizing the model selection step; please refer to the [Accepting the model section](#) for more details.



Camera settings button; please refer to the [Camera settings section](#) for more details.



Standard view button; please refer to the [Standard view section](#) for more details.



Machine edge view button; please refer to the [Machine edge view section](#) for more details.



Machine color view; please refer to the [Machine color view section](#) for more details.

Automatic area selection

The object is selected since the **Magic Wand** tool is enabled by default. The Magic Wand feature allows to locate objects on the background without user intervention.

Info

For the automatic area selection feature to function properly, the user has to employ a uniform background, and a single object with well defined edges.

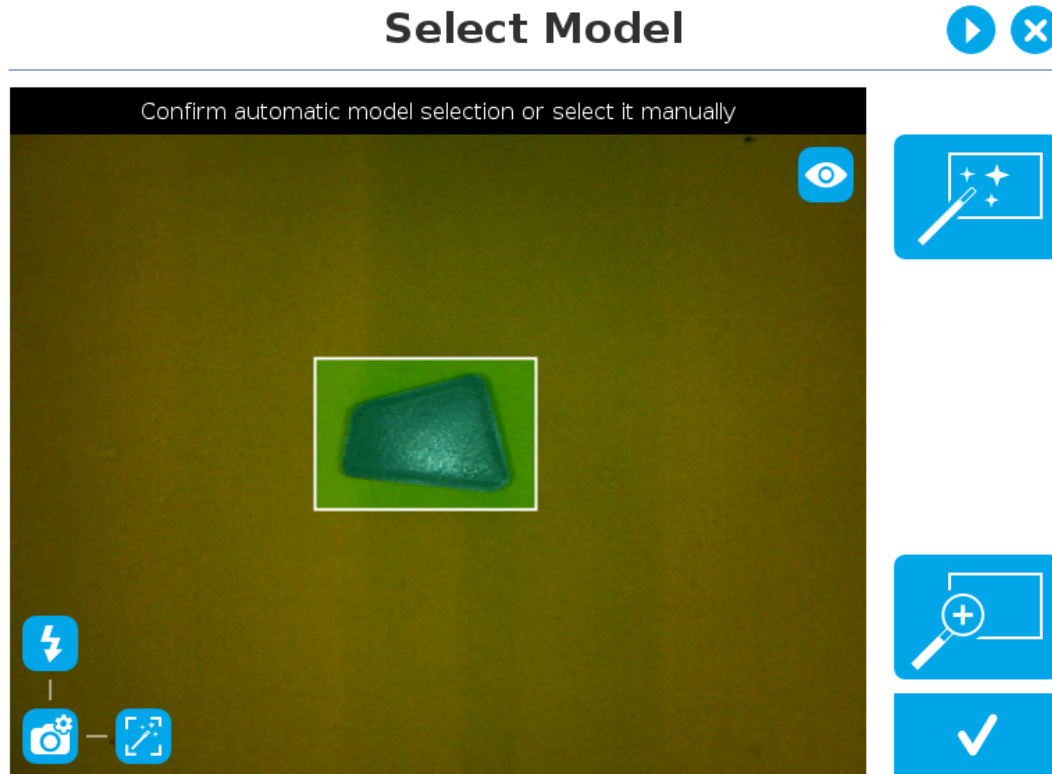

Fig. 5-4: Select Model step with object automatically selected by the Magic Wand tool

Tip

Tapping the Magic Wand tile in the right pane of the PolyScope interface switches the area selection mode to **Manual**.

Manual area selection

The user then selects an area by tapping the screen and dragging his/her finger to contain the desired object in the selection area.

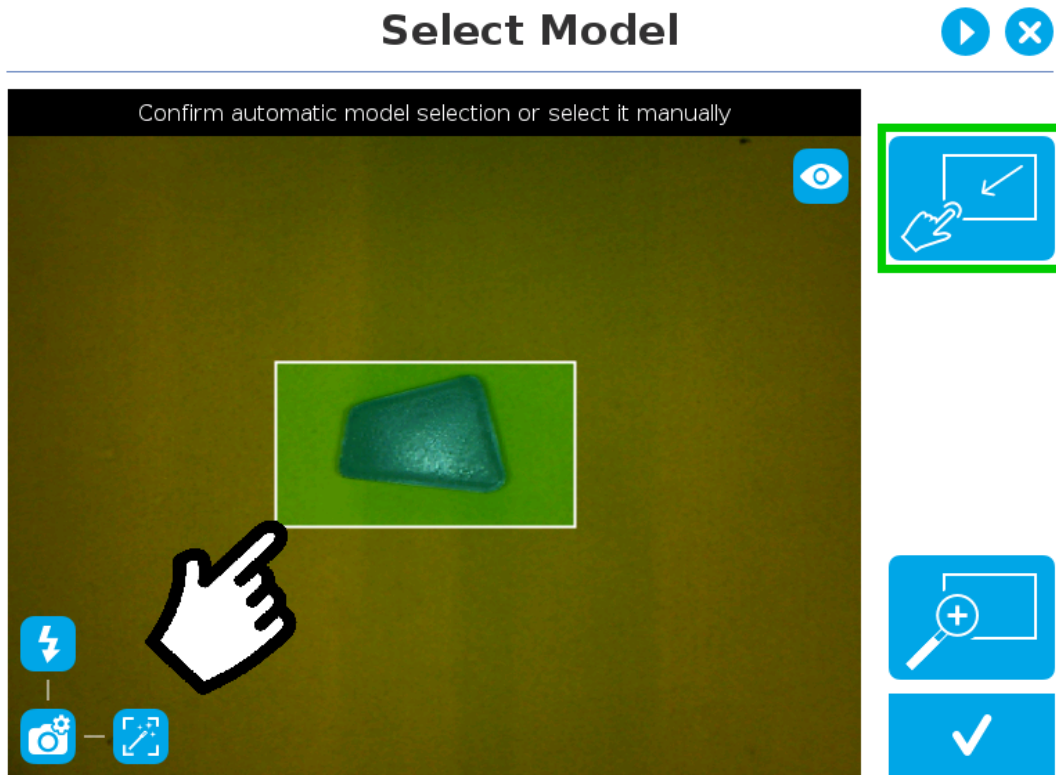

Fig. 5-5: Select Model step with Manual area selection feature

Tip

The manual area selection is useful for careful inspection of specific features using the zoom function. Refer to the [Zoom section](#) for more details.

The manual area selection can also be used for partial custom object selection (i.e. for selecting standalone features or components of an object).

Tip

Tapping the **Manual selection** button in the right pane will bring back the Automatic area selection mode.

Camera views

Standard view

When in standard view mode, the camera feed displays a reasonably faithful image based on what is normally perceived by the human eye (colored object on colored background).

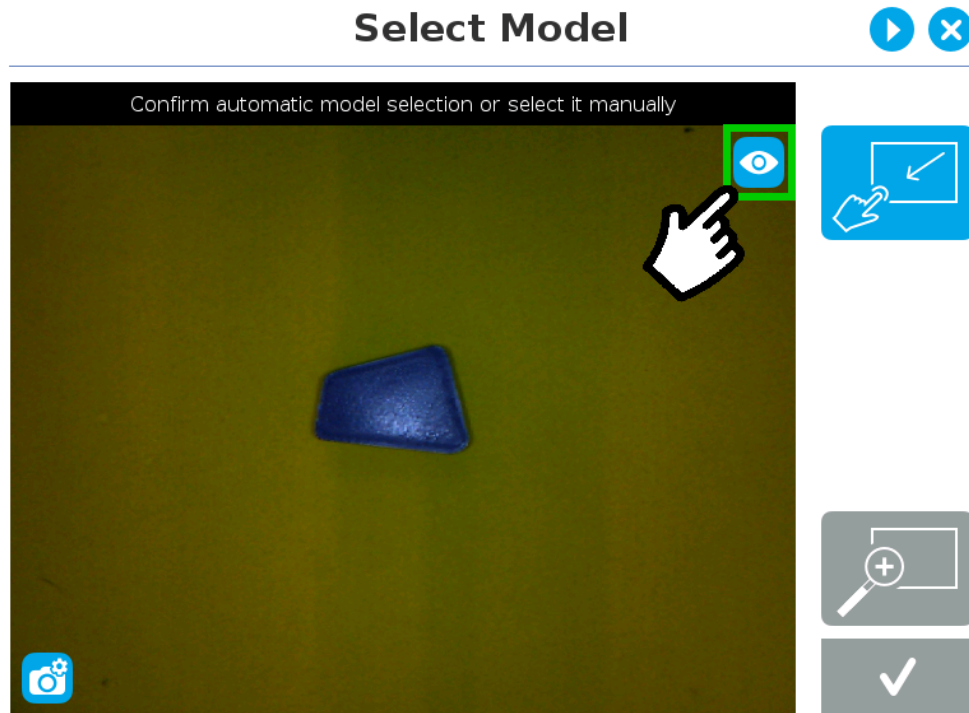

Fig. 5-6: Select Model step with standard view enabled

Tip

Tapping the **eye** button in the upper right corner of the camera feed window will bring up the **machine view**.

Machine edge view

The user can access the **machine view** by tapping the **Color view** button in the upper right corner of the camera feed window. The machine view makes no discrimination between colors; it rather highlights the contour of the selected object.

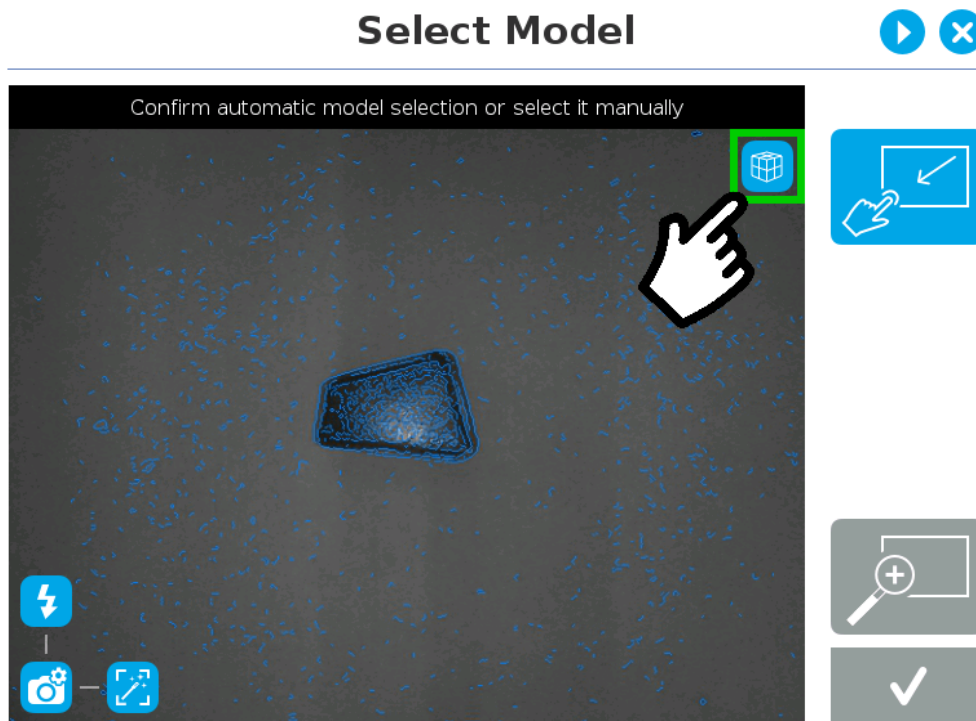

Fig. 5-7: Select Model step with Machine edge view enabled

Tip

The Machine edge view is a convenient tool that can be used to better understand the quality of the image and the object contrast, and to improve adjustments made to the selection.

Tip

Tapping the **cube** button in the upper right corner of the camera feed window will bring up the **Machine color view**.

Machine color view

The user can access the **Machine color view** by tapping the **Machine edge view** button in the upper right corner of the camera feed window. The Machine color view displays the elementary colors perceived by the vision system.

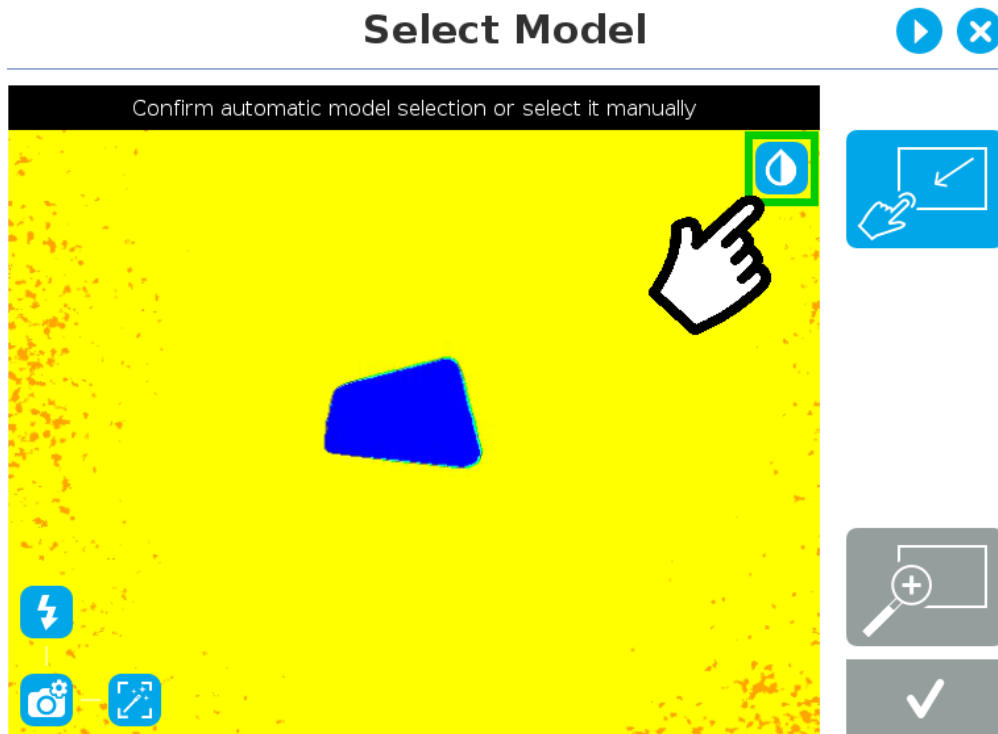

Fig. 5-8: Select Model step with Machine color view enabled

Tip

The Machine color view is a convenient tool that can be used to better understand the color signature and scale used by the system.

Tip

Tapping the **drop** button in the upper right corner of the camera feed window will bring up the **standard view**.

Camera settings

In order to access the advanced camera settings, tap the camera/gear icon in the lower left corner of the camera feed.



Camera settings



Camera LEDs are ON; please refer to the [Camera LEDs section](#) for more details.



Camera LEDs are OFF; please refer to the [Camera LEDs section](#) for more details.



Automatic focus is enabled; please refer to the [Focus section](#) for more details.



Manual focus is enabled; please refer to the [Focus section](#) for more details.



Shallow focus button; please refer to the [Focus section](#) for more details.



Deep focus button; please refer to the [Focus section](#) for more details.

Camera LEDs

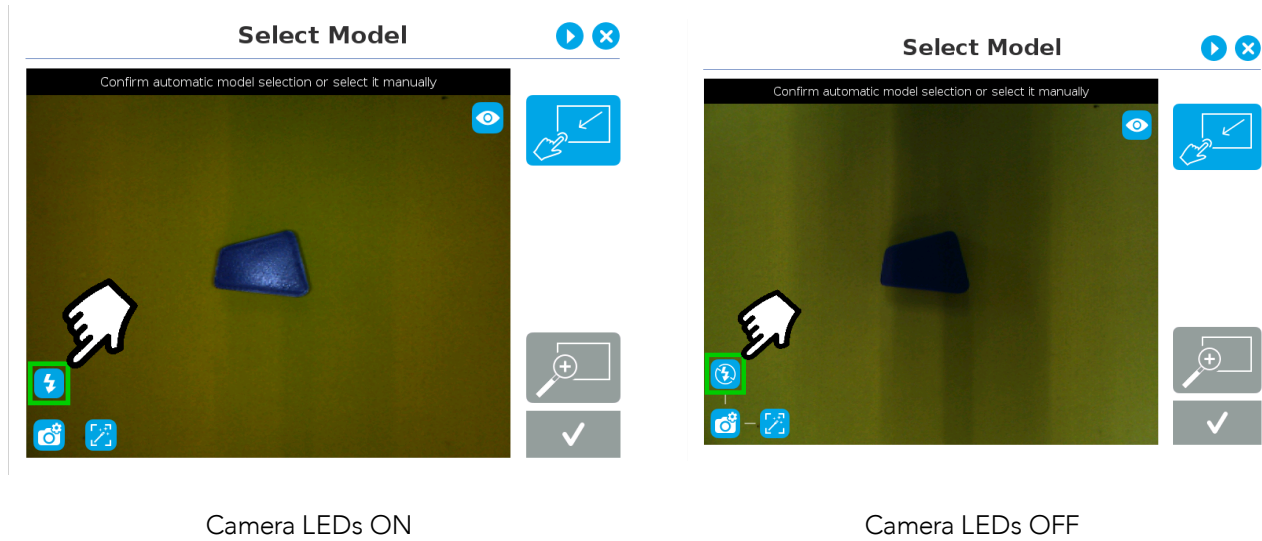
Tip

The LEDs, when turned ON, sometimes highlight undesirable features or create reflections that distort the teaching process. It is recommended to try both settings when teaching the object in order to select the most conclusive result.

Warning

The flash and focus settings selected will be used at runtime unless changes are made at the **Configure Model** step at the end of the teaching process. Please refer to the [Configure Model](#) section for more details.

Focus

Info

Focus features can be used to sharpen or diminish the contrast between the object and the background, and adjust the depth of field. The settings will be captured at runtime except if changes are made to the model during the **Configure Model** step. Please refer to the [Configure Model](#) section for more details.

Automatic focus

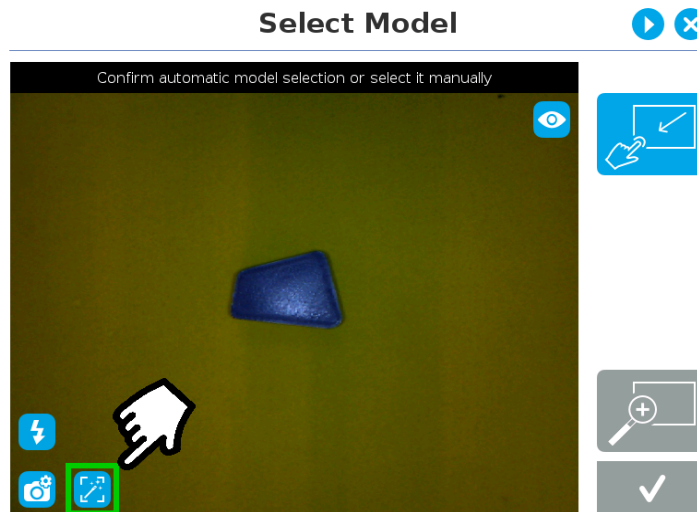

Fig. 5-9: Select Model step with automatic focus option enabled

To some extent, the automatic focus feature detects sharpness in the overall image. If the image is blurry, the autofocus system will adjust the focus until sharpness and/or contrast is achieved. This type of automatic focus requires enough contrast between the object and the background for it to render an appropriate image.

Manual focus

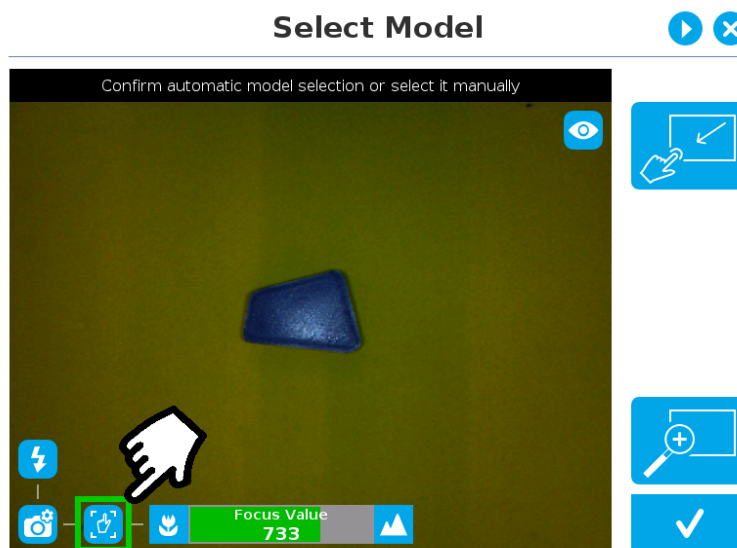

Fig. 5-10: Select Model step with manual focus option enabled

The manual focus feature allows the user to adjust the depth of field. Tapping the **flower** button reduces the focus value, making the depth of field narrower, while tapping the **mountain** button increases the focus value, making the depth of field deeper.

Zoom

The zoom-in/zoom-out tool is used to toggle between a high-level view and a more explicit view of the selection area (and object).

Zoom in

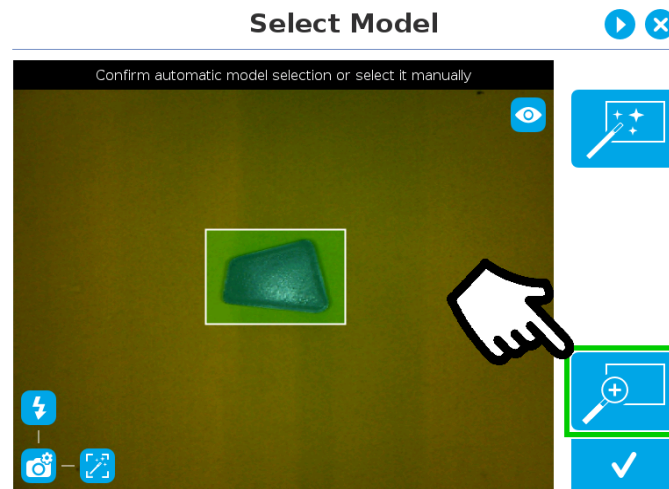

Fig. 5-11: Select Model step with Zoom in button highlighted

In order to zoom in on the selection area, the user has to tap the magnifier with a plus symbol in the lower right corner of the teach pendant interface.

Once zoomed in, the user can perform focus adjustments to improve the recognition of edges in the model.

Info

Note that when zoomed in, the user can neither change the area selection mode nor accept the model selected (the buttons are greyed out). The zoom in feature is therefore solely used for inspecting the model in details and for adjusting the depth of field via the manual focus settings.

Zoom out

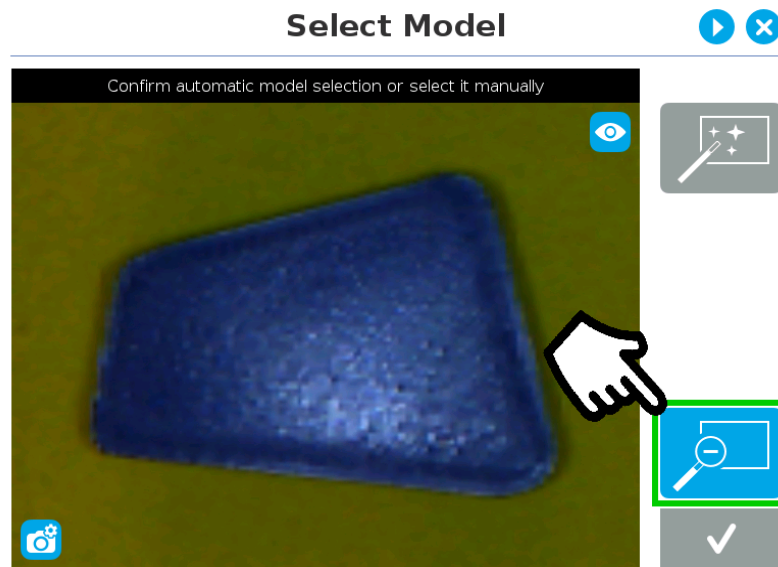

Fig. 5-12: Select Model step with Zoom out button highlighted

In order to zoom out from the selection area, the user has to tap the magnifier with a minus symbol in the lower right corner of the teach pendant interface.

Accepting the model

When the view of the model selected is satisfactory and you wish to carry on with the teaching wizard steps, tap the button with the **check mark** in the lower right corner of the teach pendant interface.

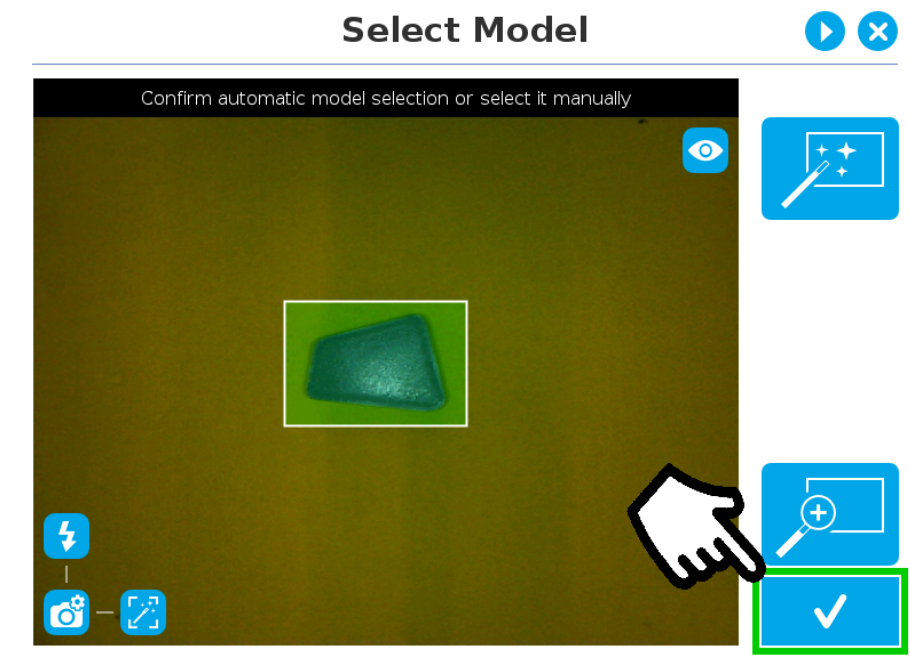

Fig. 5-13: Select Model step with Accept button highlighted

5.2.1.3. Edit Model

Tip

At any moment during the teaching process, the user can access contextual help videos with the **Play** button.

Right after accepting the model at the end of the Select Model step, the camera automatically zooms in on the object selected. Quick selection modes and tools are made available to the user.



Outline only selection mode; please refer to the [Object Teaching section](#) for more details.



Outline & surface selection model please refer to the [section](#) for more details.



Rectangle selection around object please refer to the [section](#) for more details.



Marker tool; please refer to the [Object Teaching section](#) for more details.



Eraser tool; please refer to the [Object Teaching section](#) for more details.



Rectangle+ (add area) tool; please refer to the [section](#) for more details.



Accept model button; please refer to the [Accepting the model section](#) for more details.



Delete selection area button; please refer to the [Accepting the model section](#) for more details.

Info

The user can alternate between color and machine view while editing the model. Please refer to the [Camera views section](#) for more details.

Quick selection modes

Tap the arrow to the left of the quick selection tool to expand the selection modes menu.

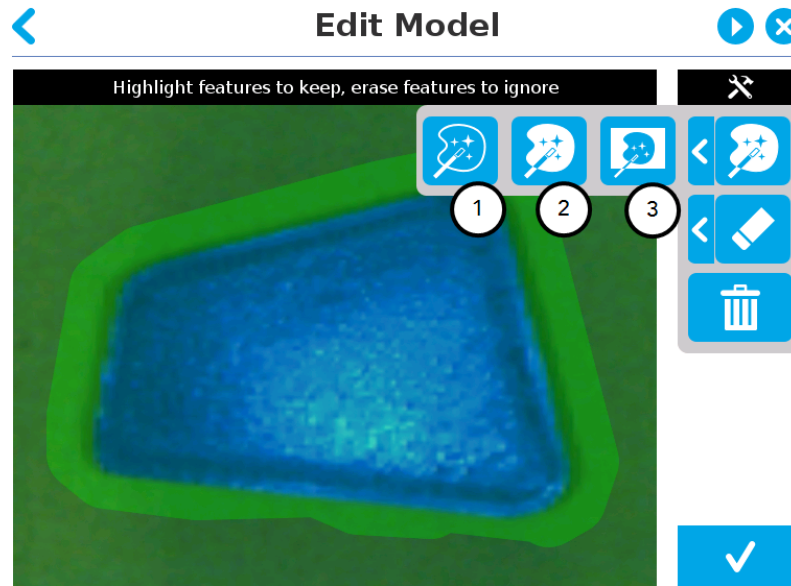

Fig. 5-14: Edit Model step with quick selection modes expanded

1 Outline only

The Outline only selection tool is used to highlight the contour of the object

Info

The selection area bleeds off the edge of the object to capture the background color.

Caution

The **Outline only** selection tool is not available for an object that has been selected manually at the Select Model step. This prevents users from selecting the partial contour of an object, which could lead to faulty contrasts and edge detection.

2 Outline & surface

The Outline & surface selection tool is used to highlight the contour and upper surface of the object. Tap the middle button. This tool is selected by default when the user accepts a model selected automatically during the Select Model step.

Info

The selection area bleeds off the edge of the object to capture the background color.

Caution

The **Outline & surface** selection tool is not available for an object that has been selected manually at the Select Model step. This prevents users from selecting the partial outline and/or surface of an object, which could lead to faulty contrasts and edge detection.

3 Rectangle around object

The Rectangle around object selection tool generates a rectangular selection area surrounding the object.

Info

The **Rectangle around object** selection tool is automatically selected when the object has been manually selected at the Select Model step. The other options are disabled. This prevents users from selecting a partial outline and/or surface of the object, which could lead to faulty contrasts, and erroneous color signature and background identification.

Tools

Tap the arrow to the left of the tools button to expand the tools menu.

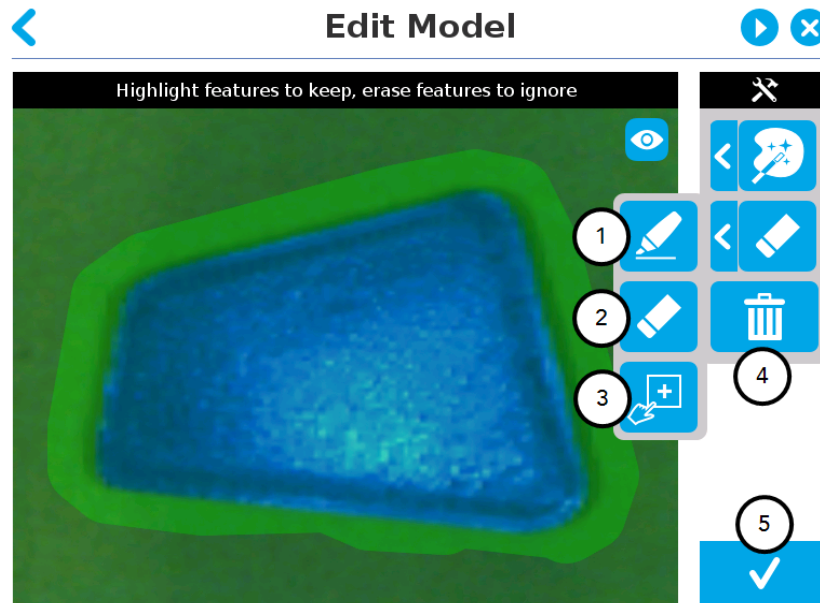

1 Marker

The marker tool can be used to highlight features and edges to **include and keep** in the selection area.

Slide your finger or pointing device on the desired area(s) on the teach pendant. A green **object layer mask** will be applied to the highlighted portion of the model.

2 Eraser

The eraser tool can be used to ignore features and edges in the selection area.

Slide your finger or pointing device on the undesired area(s) on the teach pendant. The object layer mask will be replaced by the background layer mask.

3 Rectangle+ (add area)

The rectangle+ (add area) tool can be used to quickly highlight desired areas.

Tap and drag your finger or pointing device to draw rectangular shapes that will highlight presently available features.

Deleting the selection area

4 Garbage can

Tapping the garbage can icon will clear the object layer mask, thus deleting the selection area.

Accepting the model

5 Check mark

When the view of the model is satisfactory and you wish to carry on with the teaching wizard steps, tap the button with the check mark in the lower right corner of the teach pendant interface.

Caution

Tapping the Accept model button (check mark) takes a picture of the model that will act as the first step in the next phase of the teaching process: Refine Model.

5.2.1.4. Refine Model

The Refine Model step prompts the user to take photos of the model in four different orientations. The purpose of this step is to remove shade effects associated with the edges of the object in order to refine the model.

Info

The first photo is automatically generated at the end of the Edit Model step.

Info

Tap the camera icon to take a photo between each step. An error will pop up if the object has not been rotated.

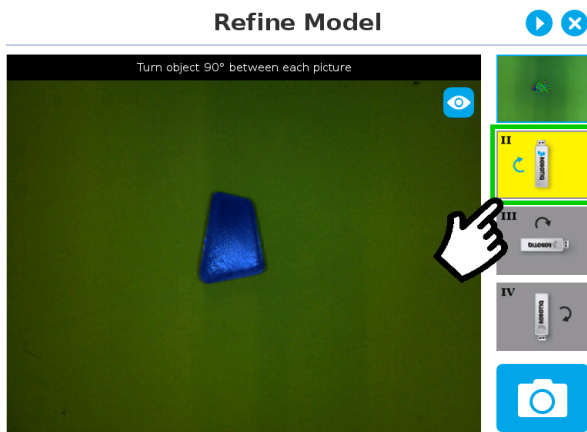

1. The user is prompted to turn the object 90 degrees clockwise. Note that the first picture is already taken, in the upper right corner.

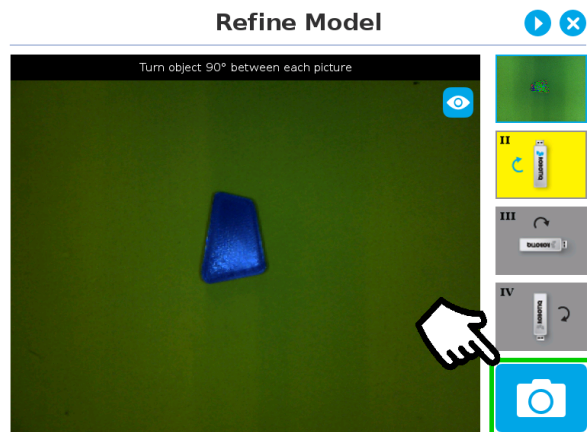

2. The user is prompted to take the second picture of the object.

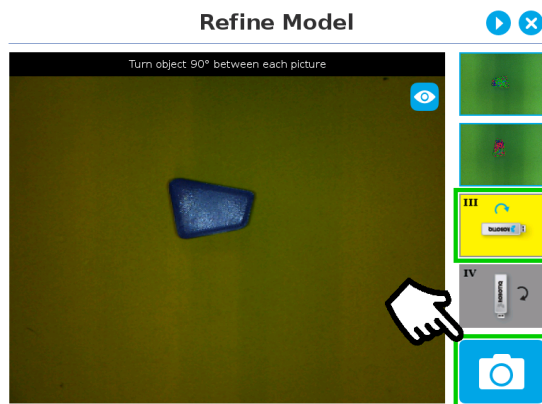

3. Object turned another 90 degrees clockwise. The user is prompted to take the third picture.

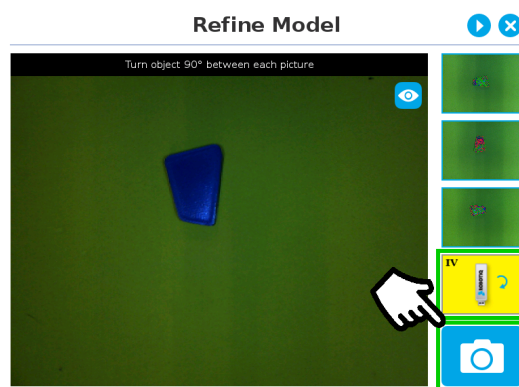

4. Object turned another 90 degrees clockwise. The user is prompted to take the fourth picture.

Tip

Tap on any snapshot taken in the object teaching wizard to enlarge it.

5.2.1.5. Validate Model

Tip

At any moment during the teaching process, the user can access contextual help videos with the **Play** button.

The Validate Model step will start right after the fourth picture is taken at the end of the Refine Model step.

Info

If the object is properly detected, it will display green and red outlines.

If the object has not been recognized, please refer to the [Guidelines on Object Teaching](#) section for instructions.



Accept button



Retake button

The Validate Model step is used to verify the contour selection of the model. If satisfactory, the user can accept the model by pressing the **Accept** button, or go through the Refine Model step again by tapping the **Retake** button.

Main points to observe:

- Object contours and detected features are outlined in green
- Features from the model that cannot be located on the object in the field of view of the camera are outlined in red.

5.2.1.6. Scan Model

Tip

At any moment during the teaching process, the user can access contextual help videos with the **Play** button.

Warning

Scanning is an automatic process; the robot will move in order to perform calibration. Make sure the robot's work space is clear. You can tap **Cancel** to stop the process. The operator should watch the robot at all time and have the emergency stop button at hand.



Scan button used to start the scanning process



Cancel button used to abort the scanning process while it is running

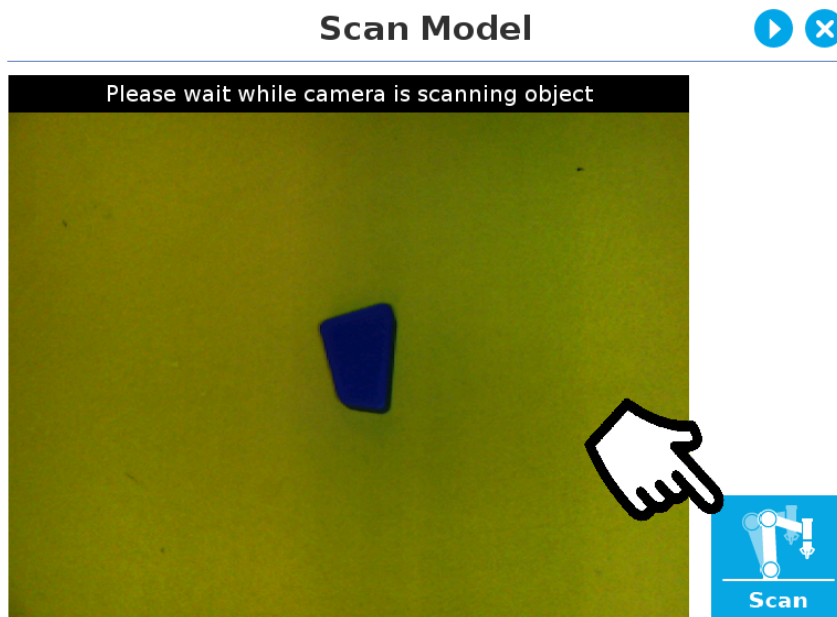

Fig. 5-15: Scan Model step with Scan button highlighted

The vision system will run a scan of the object by taking 9 pictures.

When the process is completed, the wizard will bring up the **Configure Model** step. Please refer to the [Configure Model section](#) for more information.

5.2.2. Parametric Method

When teaching a simple geometry object, it is recommended to use the **Parametric method**. It builds a model based on parameters of a basic 2D shape (circle, ring, square or rectangle). This method allows the vision system to recognize and locate with high robustness objects that have few distinctive features such as raw material blanks. It usually gives best results than the **Automatic method** for simple geometry and highly reflective objects.

Choose the geometry that corresponds to the object to detect and define its parameters:

- Circle
- Ring
- Rectangle
- Square

Caution

In all cases, the height (h) is the distance between the workplane and the 2D shape. It considers and compensates the thickness of the provided calibration board (roughly 3mm) that was used to calibrate the workplane.

Thus, if you calibrated the workplane using a printed version of the calibration board, you must add 3mm to the height measurement.



Define button used to confirm the dimensions of the object.

5.2.2.1. Circle

Tip

At any moment during the teaching process, the user can access contextual help videos with the **Play** button.

Enter the circle diameter (D) and the height (h) at which the circle is located. Tap the **Define** button.

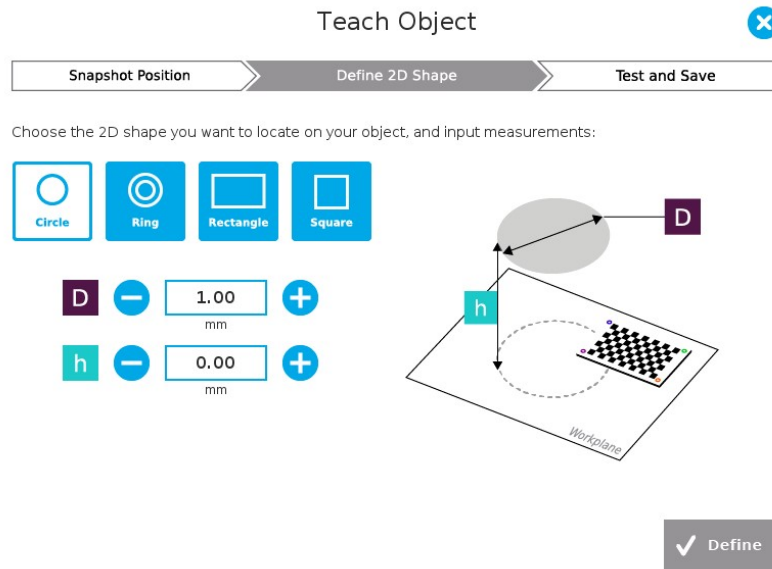

Fig. 5-16: Definition of a circle 2D shape.

5.2.2.2. Ring

Enter the ring outer diameter (D), inner diameter (d) and the height (h) at which the ring is located. Tap the **Define** button.

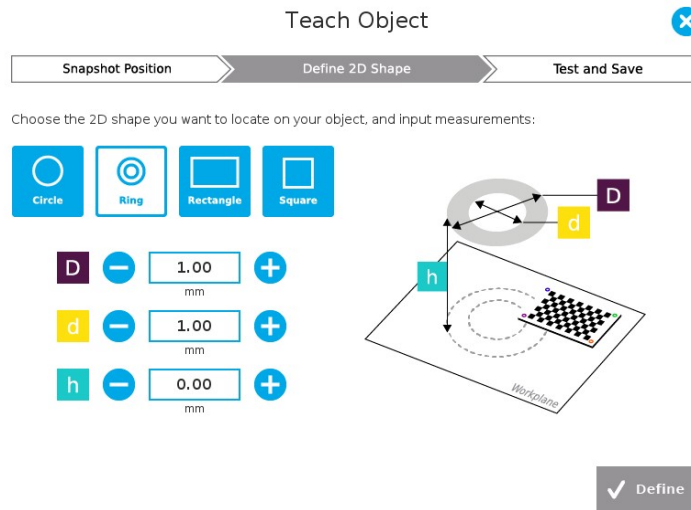

Fig. 5-17: Definition of a ring 2D shape.

5.2.2.3. Rectangle

Enter the rectangle length (l), width (w) and the height (h) at which the rectangle is located. Tap the **Define** button.

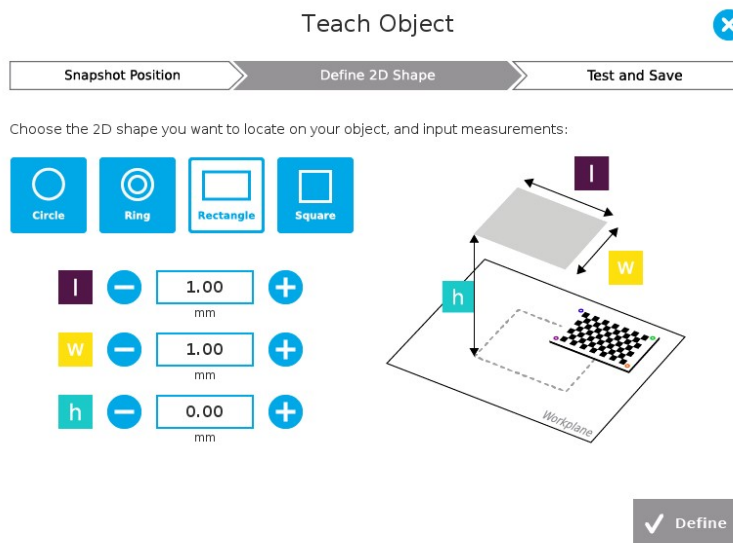

Fig. 5-18: Definition of a rectangle 2D shape.

5.2.2.4. Square

Enter the square length (l) and the height (h) at which the square is located.

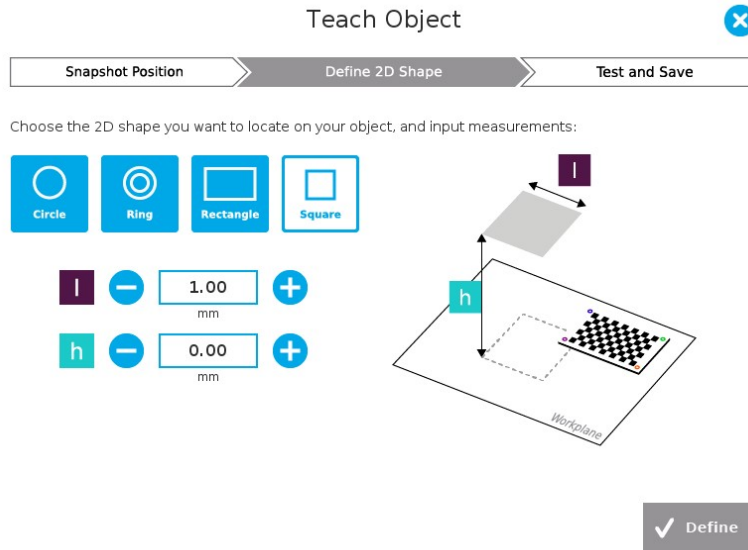

Fig. 5-19: Definition of a square 2D shape.

When the process is done, the wizard will switch to the Configure Model step. Please refer to the [Configure Model section](#) for more details.

5.2.3. Configure Model



Test locating object button; the Vision System will search for the object in the field of view of the Wrist Camera.



Back button; after testing an object's location, tap to return to the output image of the camera.



Color validation button; tap to open the color validation menu.

A colored button Indicates that the color validation mode is enabled.

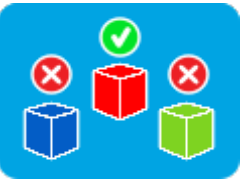

Please refer to the [Color Validation section](#) for more details.



Multiple Object Detection button; a grey button means the feature is not available at the moment.



Tap to open the multi-object detection menu.



Detection Threshold button; tap to expand the detection threshold menu. Please refer to the [Detection thresholds and scores section](#) for more details.



Minus button; tap to lower the Detection Threshold. Please refer to the [Detection thresholds and scores section](#) for more details.



Plus button; tap to increase the Detection Threshold. Please refer to the [Detection thresholds and scores section](#) for more details.



Camera settings button; please refer to the [Camera settings section](#) for more details.



Score value box; display section in which the detection score appears after testing the object location.



Object location button; when an object is found, tap this button to view its position relative to the robot base.



Set reference position button; tap to save the object's position for programming linear move (MoveL) relative to the object's location. Please refer to the [Save location section](#) for more details.



Save & finish button; tap to save the detection threshold, the reference position and finish the wizard.



Test/Modify button; accessible via the Command tab of the Program Robot interface in Polyscope, once the object teaching wizard is completed. Tap to access the Test and Modify wizard. It allows the user to modify the detection threshold and the saved object position.



Reset button; accessible via the Command tab of the Program Robot interface in Polyscope, once the Teach object wizard is completed. Tap to reset the whole process of the object teaching wizard.

5.2.3.1. Multiple objects detection

In order to enable the multiple objects detection, tap the multi-object button from the Configure Model step.

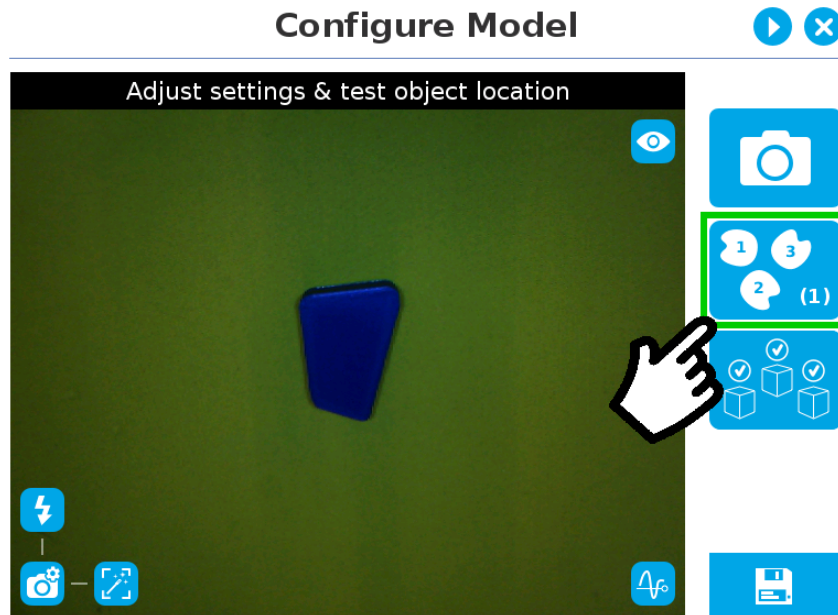

Fig. 5-20: Configure Model with multi-object button highlighted.

Once in the multi-object menu, tap the plus (+) symbol to increase the maximum number of objects to detect, or tap the minus (-) symbol to reduce that number.

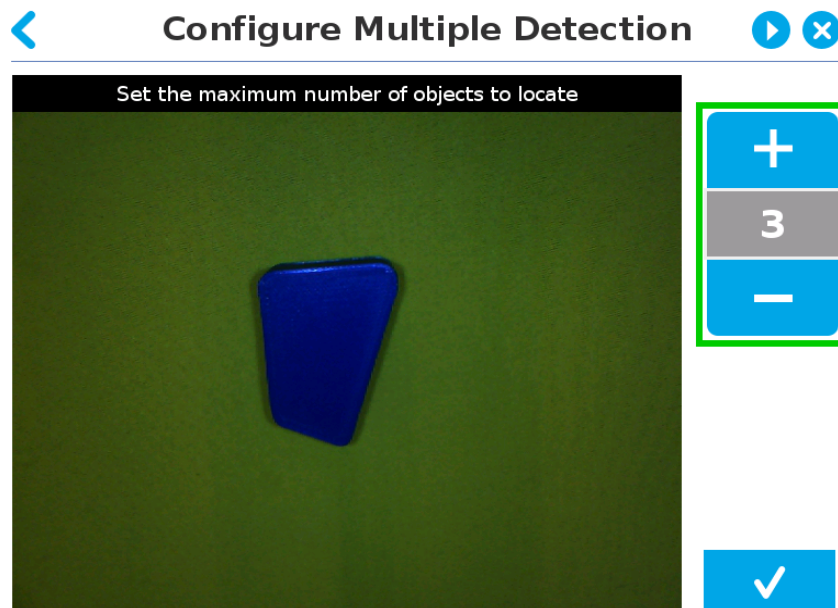

Fig. 5-21: Configure Multiple Detection menu.

5.2.3.2. Color Validation

Color validation adds reliability to the camera locate feature.

Whereas editing the model allows to select, configure and save the shape, outline and area of the model, the color validation allows the system to save the color signature of objects or features.

Warning

Color validation is not intended for discriminating between two colors in the same Camera Locate node, no matter what the purpose is. However, this action can be performed and programmed with two or more Camera Locate nodes in the same program tree.

Color validation is not intended for eliminating all colors but one in a Camera Locate node, no matter what the purpose is.

Automatic method

- 1 Tap the color validation button to access the color validation menu

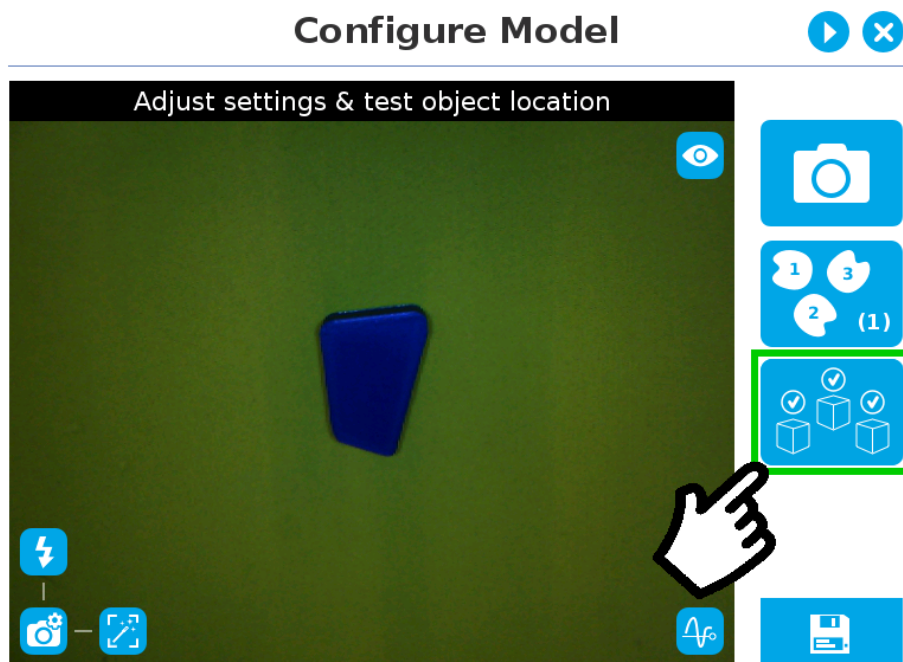

Fig. 5-22: Configure Model with color validation button highlighted.

- Turn on color validation by tapping the red button on the right side of the screen.

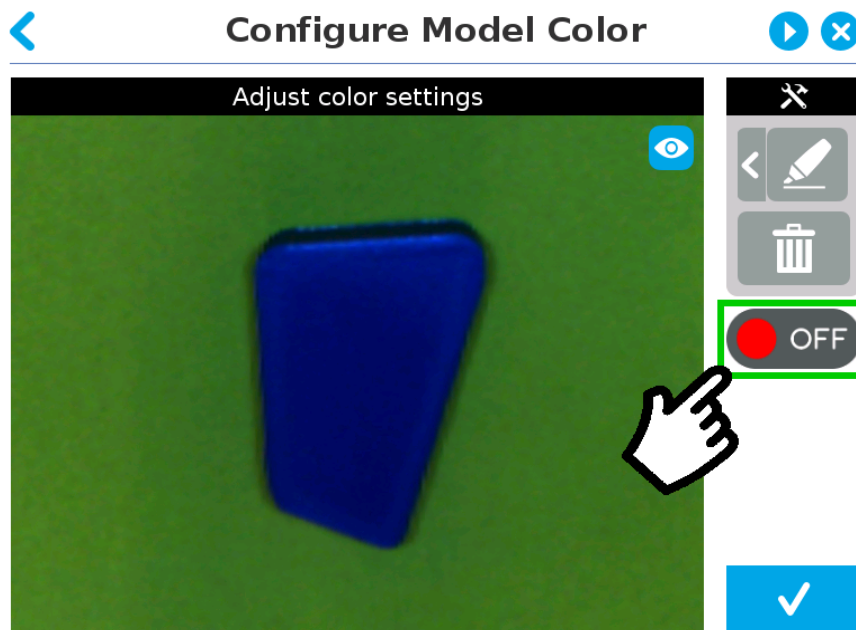
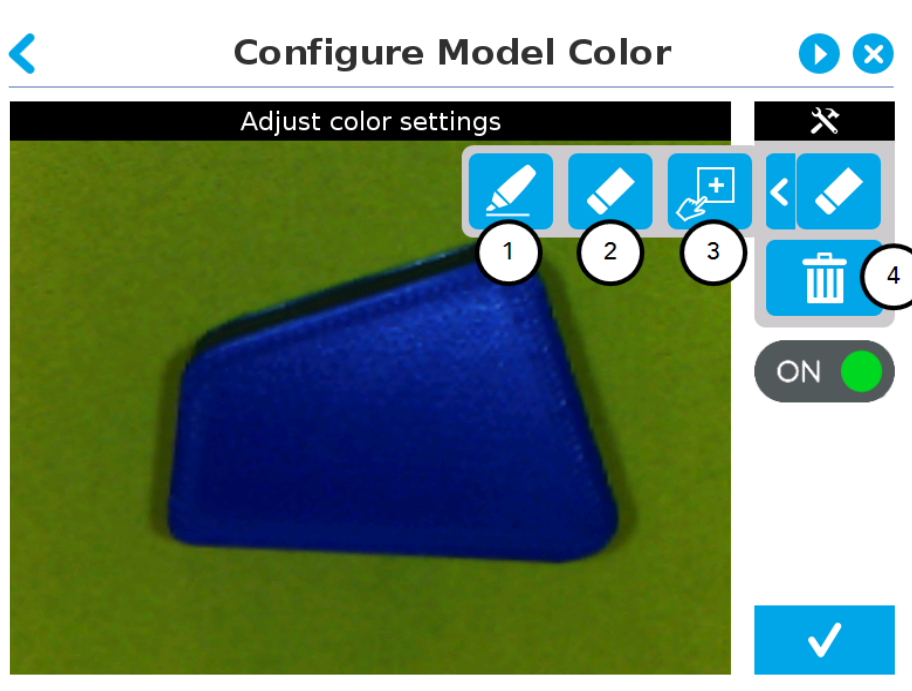

Fig. 5-23: Configure Model Color model with ON/OFF button highlighted

Color sampling tools



1 Marker

The marker tool can be used to highlight features and edges to **include and keep** in the color sampling area.

Slide your finger or pointing device on the desired area(s) on the teach pendant. A green layer mask will be applied to the highlighted portion of the model.

2 Eraser

The eraser tool can be used to ignore features and edges in the color sampling area.

Slide your finger or pointing device on the undesired area(s) on the teach pendant.

3 Rectangle+ (add area)

The rectangle+ (add area) tool can be used to quickly highlight desired areas for color sampling.

Tap and drag your finger or pointing device to draw rectangular shapes that will highlight available features.

4 Garbage can

Tapping the garbage can icon will clear the object layer mask, thus deleting the selection area.

Info

The validation routine of the camera is performed in two steps:

- 1 Contour (edge) validation, with its own detection score
- 2 Color validation (if applicable), with its own detection score

Tip

Using the color validation helps to avoid false detections in your background.

Parametric method

- 1 Tap the color validation button to access the color validation menu.

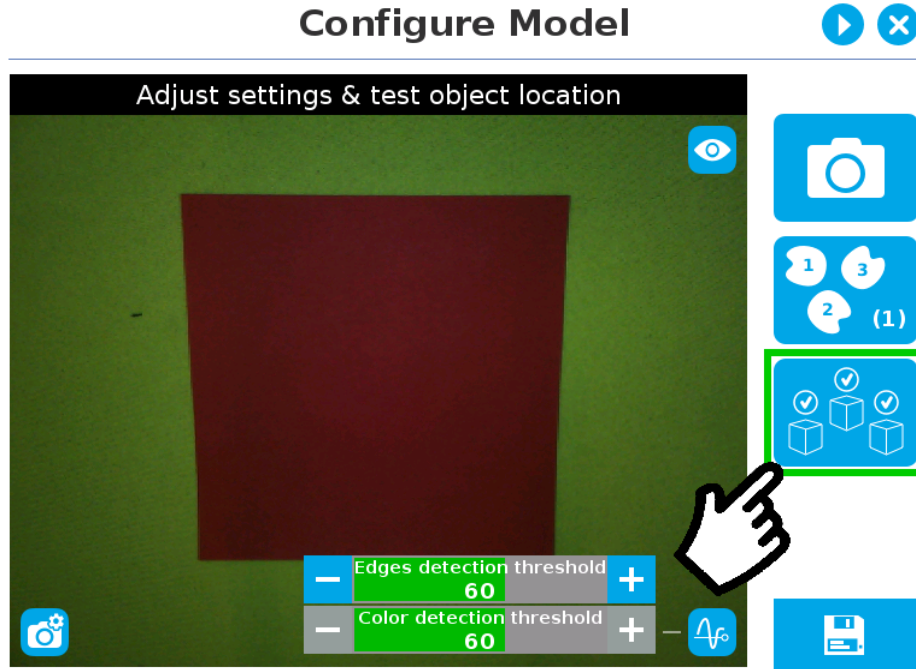

Fig. 5-24: Configure Model Step (Parametric method) with color validation button highlighted.

- Turn on color validation by tapping the red button on the right side of the screen.

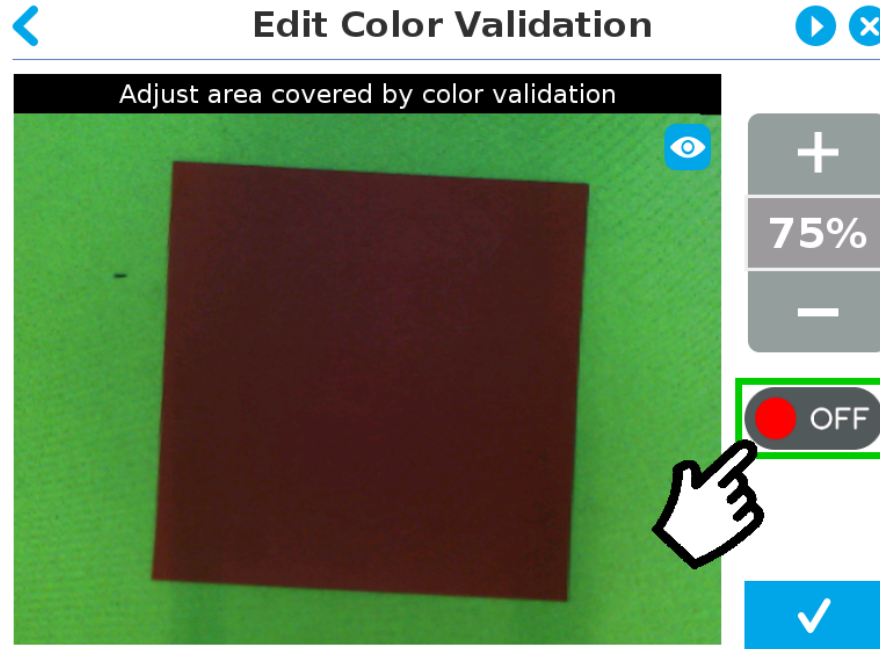
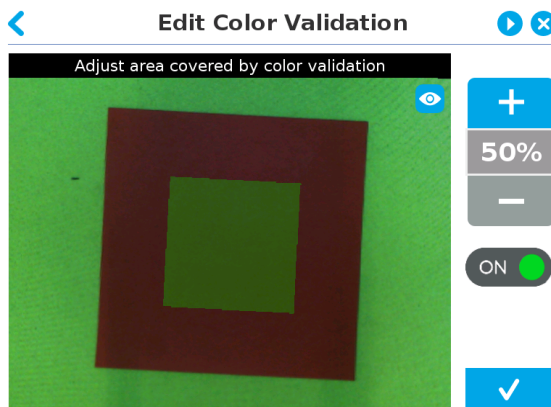

Fig. 5-25: Edit Color Validation menu (Parametric method) with ON/OFF toggle button highlighted.

Color sampling tool

In the parametric method, given the inherent symmetry of the objects located by the system, color validation is supported via an expendable/shrinkable color selection zone, on par with the contour of the object to be located.

Tap the plus icon to expand the color selection zone, and tap the minus button to shrink the selection zone.



Color selection zone (50% of object size)

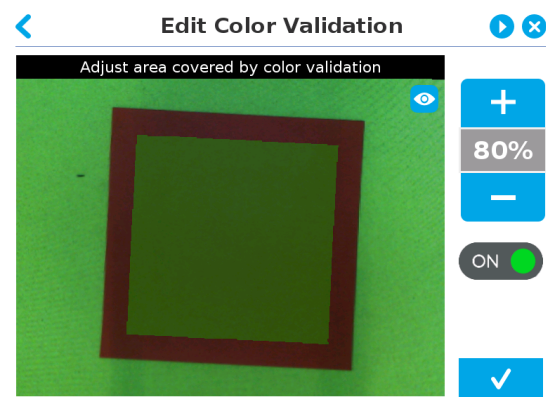

Color selection zone (80% of object size)

Caution

The size of the color selection zone ranges from 50% of the object size to 150% of the object size.

5.2.3.3. Detection thresholds and scores

At the Configure model step, the user can tap the Detection threshold button in the lower right corner to expand the detection threshold settings.

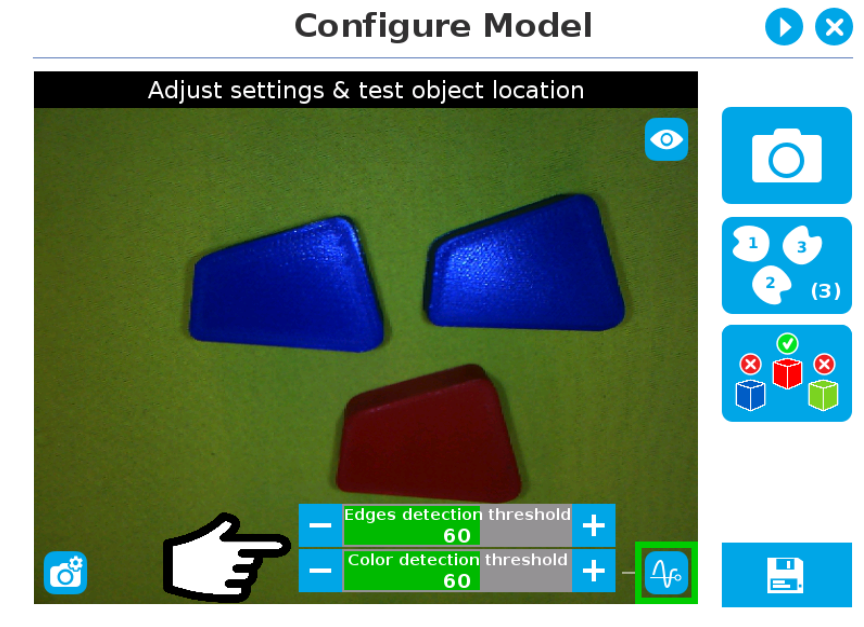

Fig. 5-26: Configure Model Step with detection thresholds highlighted.

After adjusting the detection thresholds, if applicable, the user can test the location of the object(s) in the field of view by tapping the camera icon.

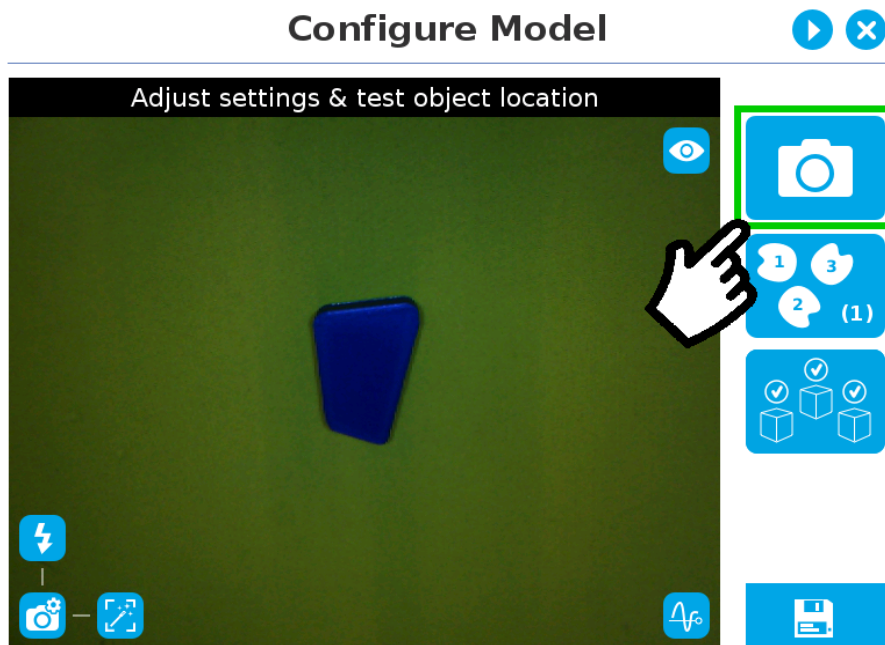

Fig. 5-27: Configure Model Step with camera icon highlighted.

Info

In the context of multiple objects detection, each object detected has its own set of detection score values (%).

Edges detection threshold and score

If the object is found, you will see the object outlined, surrounded by a blue rectangle, with the detection score value (%).

Other objects detected will be surrounded by a white rectangle. Tap the other object(s) to display their own set of detection score values.

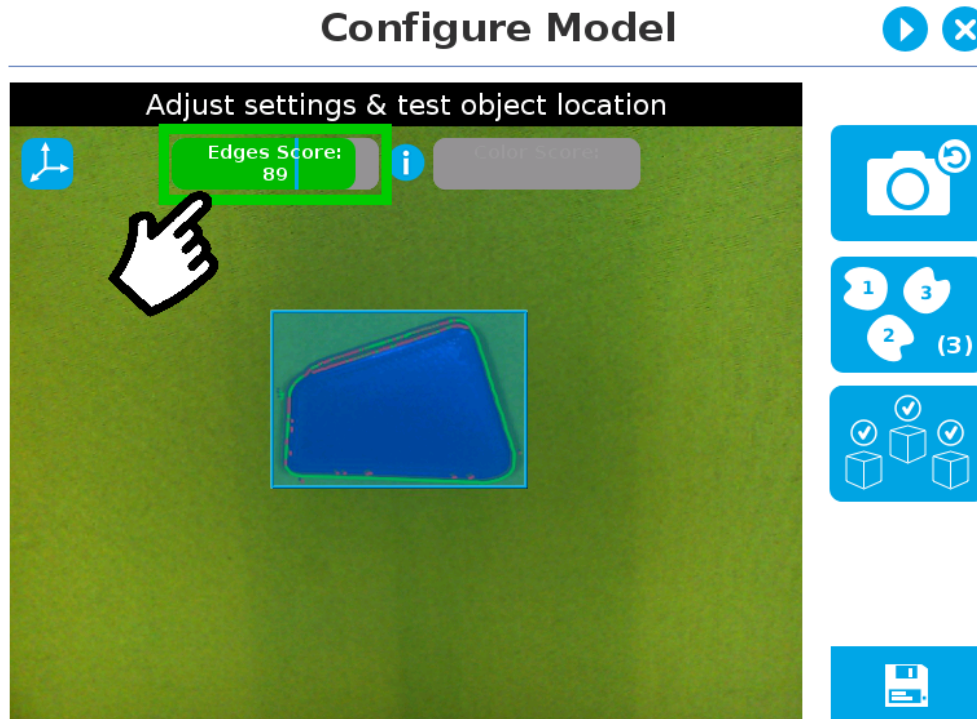

Fig. 5-28: Object found with detection score.

- If no object is found, an error message will display, reading that the object was not found.

When testing the object(s) locating:

- Object contours and detected features are outlined in green
- Features from the model that cannot be located on the object in the field of view of the camera are outlined in red.

Info

In the context of multiple objects detection, each object detected has its own set of detection score values (%).

Info

When performing the localization test, place the whole object over the workplane. Due to the perspective effect, some or all of the object features might not be recognized. If an important feature needs to be found for your application (a hole for example), make sure it is found during all localization tests. Again, green contour should match the object outlines at all times.

Tip

To avoid false detections, remove the object from the workplane, decrease the detection threshold to 0% and try to locate the object. If a false detection occurs on your workplane, you will see an object detected with the detection score. Increase the detection threshold above this score to avoid false detection.

- Try all areas of the workplane on which the object might be found. Adjust the detection threshold properly for the object and for the runtime environment.
- Adjust the detection threshold with the plus (+) and minus (-) buttons.

Tip

Set the detection threshold at the highest value possible so the vision system detects the object on the whole workplane. Tap the **Test locating object** button to test the threshold.

This ensures optimal robustness for object detection everywhere on the workplane. If it is not possible to reach such a success rate, the following should be considered:

- Redefine the Cam Locate node (go through the Teach object wizard again), make sure there are no reflections, or as few as possible.
- Refer to the [Guidelines on Object Teaching section](#) for instructions

Tip

After completing the object teaching wizard, it is possible to edit the detection threshold. To do so, select the Camera Locate node and go to the Command tab. Click on **Test/Modify** to edit the threshold and/or modify the position of the object.

Color detection threshold and score

Color detection can only happen following a successful edge detection.

Caution

Color validation must be enabled in order to go through the color detection step. Please refer to the [Color Validation section](#) for more details on enabling color validation.

If the object goes through the 2-step detection successfully, you will see the object(s) outlined, surrounded by a blue rectangle, with the detection score values (%).

Other objects detected will be surrounded by a white rectangle. Tap the other object(s) to display their own set of detection score values.

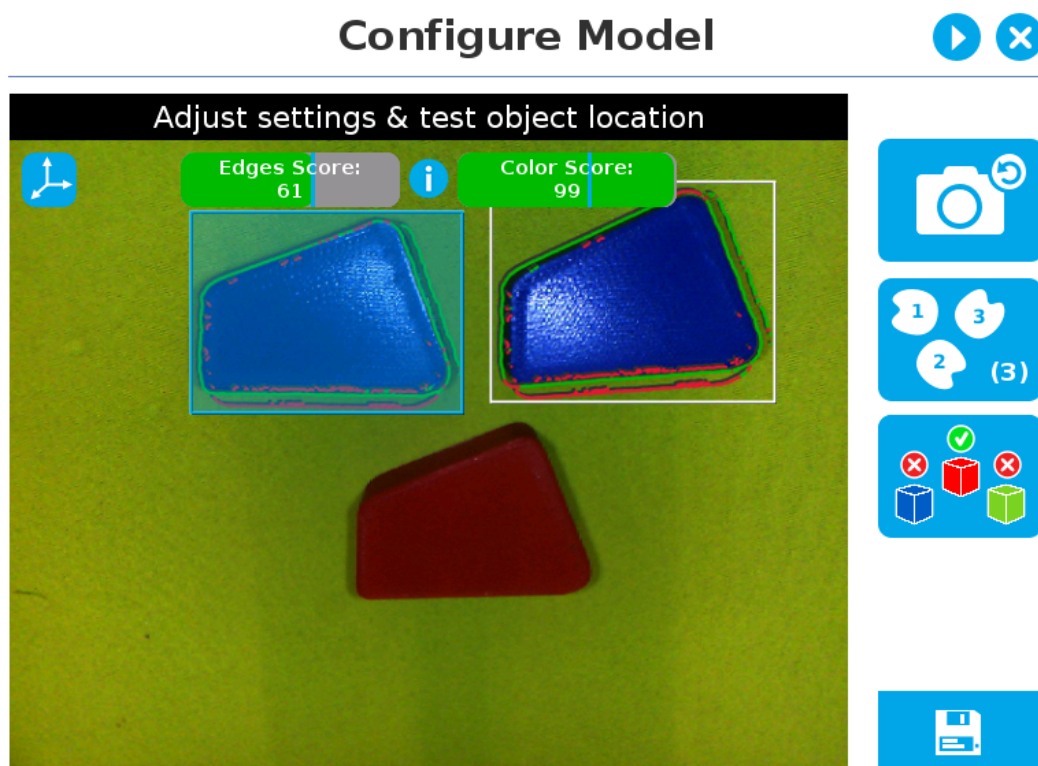

Fig. 5-29: Multiple objects found each with their selection rectangles and detection scores.

Info

In the context of multiple objects detection, each object detected has its own set of detection score values (%).

5.2.3.4. Camera settings

Warning

Camera settings can be adjusted at the **Select Model** step of the Automatic teaching method **and/or** at the **Configure Model** step of the Teach object wizard.

Editing the camera settings at the Configure Model step will override the settings selected at the Select Model step of the Automatic teaching method.

Please refer to the [Camera settings](#) section for more details.

5.2.3.5. Save location

Once you are done with the test and adjustment, tap the Set reference position button.

Caution

Do not move the object after saving the position; the subsequent relative movements programmed will be relative to that position. Please refer to the [Programming with the Camera Locate Node](#) section for more details.

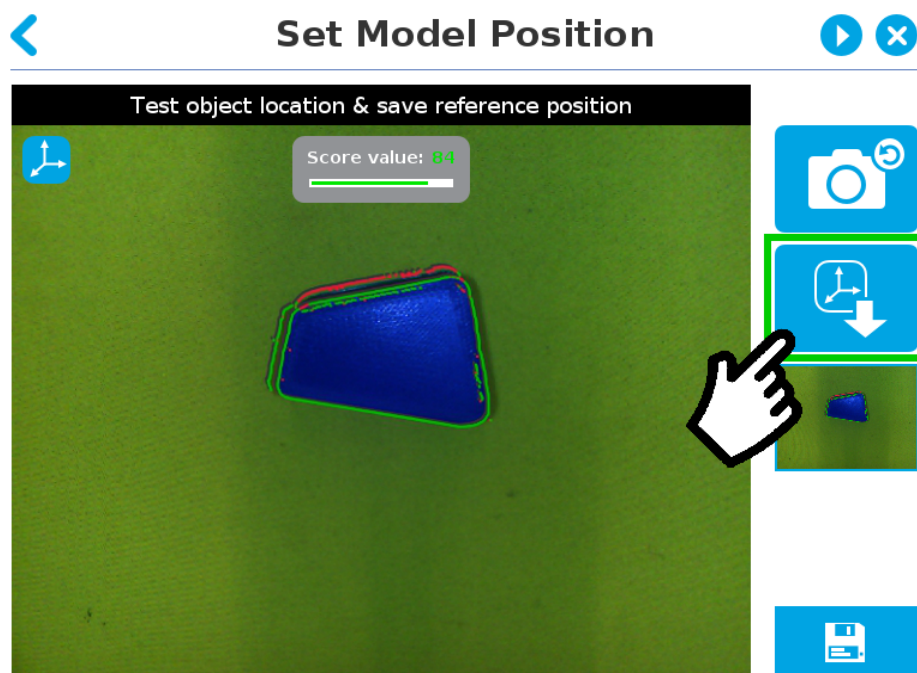

Fig. 5-30: Position defined.

Once the position is saved, tap the **Save & Reset** button in the lower right corner of the teach pendant interface.

When you are done with the teaching process, the Camera Locate node will show you a snapshot of your saved object. You can tap **Reset** to redefine completely. You can tap **Test / Modify** to change the detection threshold or both the threshold and the saved object position.

6. Programming with the Camera Locate Node

Fast Cycle Time

If the ambient lighting is stable during run-time, you can enable the fast cycle time configuration. To do so, go to the Installation tab from the program. Choose **Camera** and go to **Configurations**.

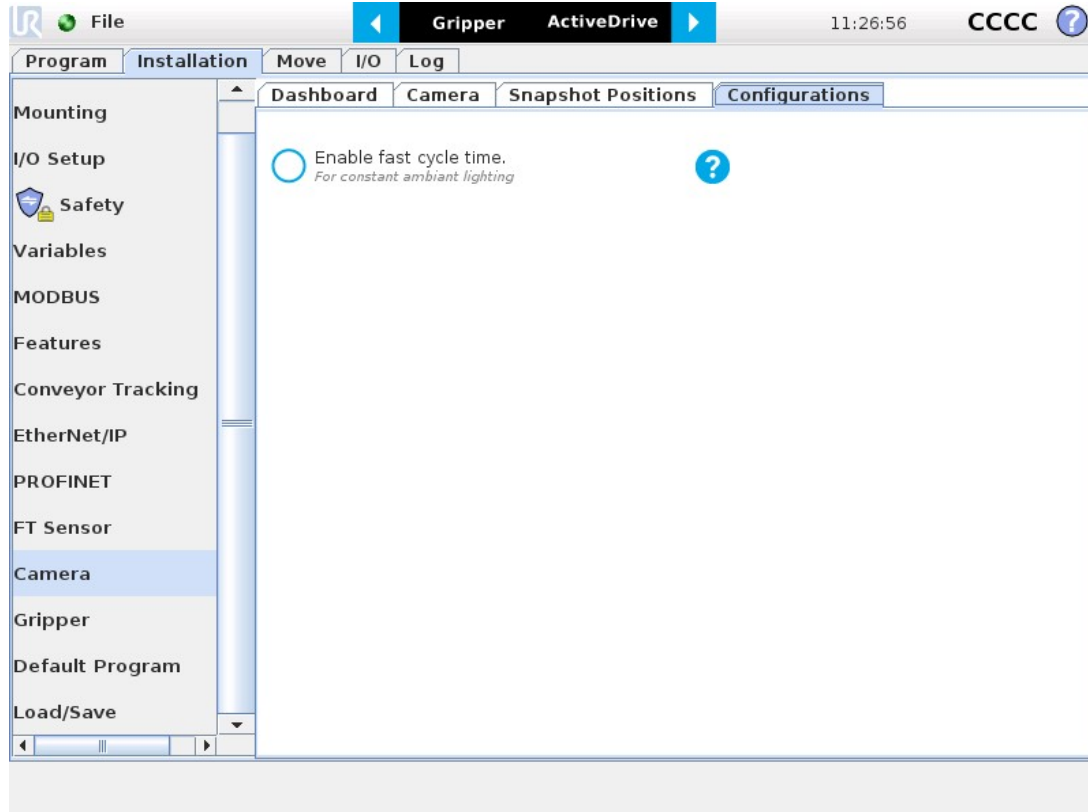

Fig. 6-1: Enable fast cycle time when ambient lighting is fixed.

By enabling the fast cycle time configuration, the camera exposure will be set the first time the program enters a Camera Locate node – at runtime. For all other Camera Locate nodes, the camera will keep the exposure settings from the first run. This reduces the cycle time by half as opposed to not enabling the fast cycle time configuration.

Fast Cycle Time



Fast cycle time	Behaviour of the vision system	Which to choose?
<input checked="" type="radio"/> Enabled	The camera exposure is set once, at the first iteration, and used for all subsequent iterations.	Enables better cycle time. Should be used only when ambient lighting is constant.
<input type="radio"/> Disabled	The camera exposure is set at each iteration.	Allows for more robust part location under fluctuating lighting conditions, but may double the cycle time (compared to a "fast cycle").

Fig. 6-2: Fast cycle time configuration.

Fast Cycle Time

Enable the fast cycle time configuration **only if the external ambient lighting is constant.**

Programming

The first thing to do after completing the object teaching is to add a Move node to the Snapshot position. When you exit the object teaching wizard, the robot arm is already in the Snapshot position location. You can simply add a MoveJ command before the Camera Locate node and set it to the location the robot arm is at (see Snapshot_pos_1 from the next figure).

Caution

Make sure the robot arm is moved to the snapshot position before the Camera Locate node in the robot program.

The Camera Locate node acts as an "if" statement. If the taught object is detected by the camera, the robot program will enter in the Camera Locate node and execute all the command lines within it.

After teaching the object within the Camera Locate node, you may continue the programming by using either a linear move (MoveL) with the snapshot position's variable as feature or the object_location pose. It is also possible to edit the detection threshold or the saved object position after the Teach Object wizard.

- Refer to Section 6.1 to program a robot motion with a linear move (MoveL) with the snapshot position's variable as feature. This allows to perform robot motion relative to the object detected at run time.
- Refer to Section 6.2 to use the object_location pose to program the robot motion - for advanced use.
- Refer to Section 6.3 to edit the detection threshold and/or the saved object position.

Cycle Time

The Camera Locate node cycle time is influenced by the background complexity, the object's features complexity and the number of objects on the workplane.

To reduce the Camera Locate cycle time, consider the following:

- Have the least possible objects and object types on your workplane at run time.
- If your object has many detailed features, you can teach a drawing of it with simplified features or teach only one area of the object.
- Have a diffuse ambient lighting, avoiding high light intensity spots on the workplane.

6.1. Linear Move with Feature

Once the Teach Object wizard is completed, you saved the last position of your object. The object position variable, named after the snapshot position, now contains the reference frame of the object in this saved position. Each time the Camera Locate node localizes an object, it updates that feature variable's frame with the new detected object's position and orientation. That feature is named according to the feature name you chose during the snapshot position definition.

Saved position

The saved object position from the Teach Object wizard or the Test/Save wizard is the position of the object to be used for the relative robot motion programming. Once the position is saved, do not move the object to ensure proper robot motion programming within the Camera Locate node.

You can use that reference feature inside the Camera Locate node within Move commands of the robot. To do so:

- Insert a Move node.
- In that node, go to the Command tab.
- Select MoveL.
- Select the appropriate feature (your Snapshot Position / Feature name).

Every waypoint inserted within that MoveL node will be relative to the feature updated by the Camera Locate.

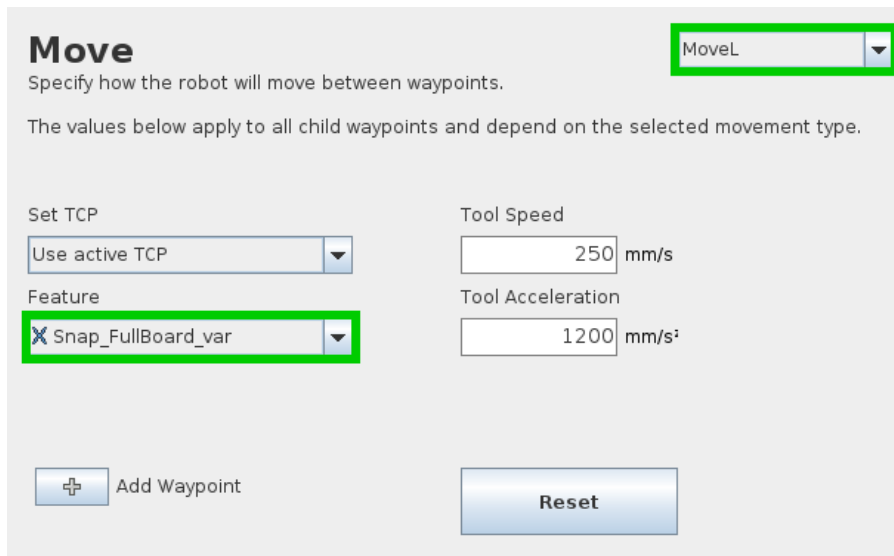

6.2. object_location pose

Once a snapshot position is defined, the workplane used for the calibration gets its own coordinate system, regardless of its orientation. This coordinate system is shown in the figure below.

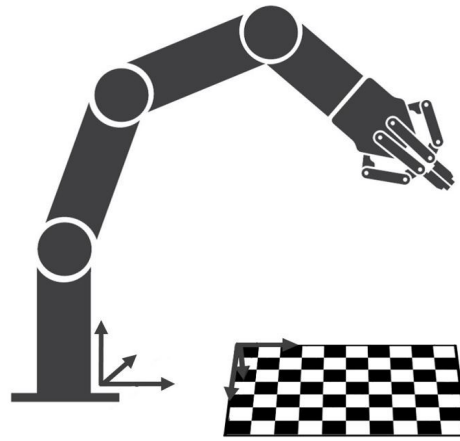

Fig. 6-3: workplane reference frame.

The camera will detect an object on the workplane and find its X-Y position, as well as its Z-orientation in the workplane's coordinate system (see figure below). Thus, a detected object is always laid flat (parallel) to the workplane. It is possible to use the **object_location** pose, which is a variable containing the detected object's pose ($p[x, y, z, x \text{ rotation}, y \text{ rotation}, z \text{ rotation}]$) in the robot's base reference frame. This variable is updated each time the program goes within a Camera Locate node, thus every time an object is detected, regardless of how many Camera Locate nodes are in the program. The **object_location** pose is relative to the robot's base frame.

Info

object_location is a variable containing the detected object's position and orientation relative to the base reference frame. The orientation is always parallel to the workplane on which the calibration has been performed. Thus, the object's X and Y axes are always parallel to the workplane. The Z axis is always normal to the workplane and points downwards from it, into the workplane (refer to the figure below).

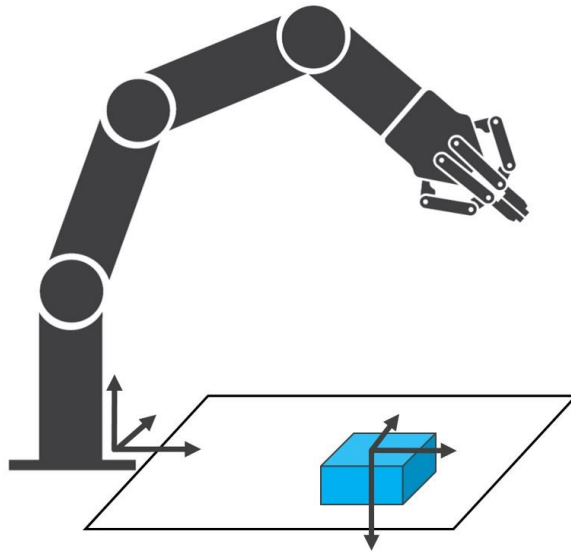

Fig. 6-4: *object_location* pose on the workplane used for the calibration.

object_location is a variable with the pose structure (x, y, z, x rotation, y rotation, z rotation):

x: x position of the object detected, relative to the robot's base reference frame.

y: y position of the object detected, relative to the robot's base reference frame.

z: z position of the object detected, relative to the robot's base reference frame.

x rotation: x rotation from the robot's base frame to the detected object feature reference frame. The object's X axis is parallel to the workplane on which the calibration has been performed.

y rotation: y rotation from the robot's base frame to the detected object feature reference frame. The object's Y axis is parallel to the workplane on which the calibration has been performed.

z rotation: z rotation from the robot's base frame to the detected object feature reference frame. The object's Z axis is normal to the workplane on which the calibration has been performed, points downwards from it, into the workplane.

If you move the robot's TCP to the *object_location* pose, the TCP will go and point the object on the workplane. The height value of the object on the workplane should not be taken into account - the TCP might be directly on the object when moving it to the *object_location* pose.

Program Example

The program examples below show how to use the `object_location` pose variable. The first one simply moves the robot so that the TCP goes directly on the detected object. Make sure the TCP is set properly to avoid collisions.

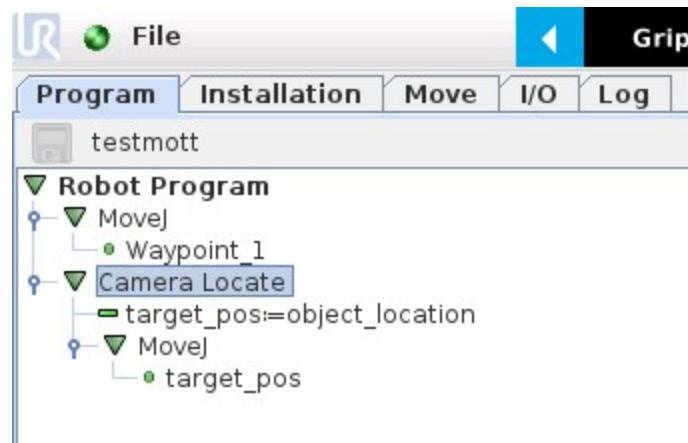

Fig. 6-5: Program example - place the TCP on the detected object.

The second example moves the robot so that the TCP goes 20 cm above the detected object. This is in the case of an horizontal plane.

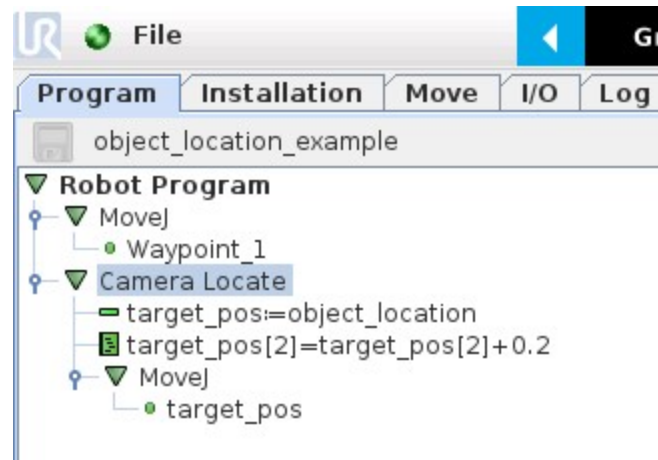

Fig. 6-6: Program example – Place the TCP 20 cm above the detected object, in case of an horizontal plane.

6.3. Edit Detection Threshold and Object Location

It is possible to edit both the detection threshold and the object location after the Teach object wizard has been completed. To do so, select the Cam Locate node, go to the Command tab and tap Test/Modify.

- To modify the saved object position, place the object in the desired position. Test is with the Test locating object button and, when in the desired position, tap Define new position. The position is saved. Tap Save & close to exit the wizard. This also saves the threshold.
- To modify only the detection threshold, modify it and test it. Once it is at the required value, tap Save & close. This does not modify the object position previously saved.
- To modify both the threshold and the object location, adjust the threshold, place the object in the desired position and test is with the Test locating object button. Once in the desired position, tap Define new position. The position is saved. Tap Save & close to save the threshold.

6.4. Camera Locate node at a variable Snapshot position

During a robot program, the robot must be at the snapshot position before entering the Camera Locate node. If it is not in the right position, a pop-up will appear, preventing the camera from taking a snapshot from the wrong position. This is to ensure good precision since the workplane has been previously calibrated for this snapshot position.

In some cases, it is helpful to move the robot to a variable position to enter a Camera Locate node. For instance, it can also be used to teach only one snapshot position and object to manage parts in stacked trays. In order to do so, allow the robot to be in a different position than the original snapshot position by entering the script command:

ignore_snapshot_position = True

You also need to edit the **snapshot_position_offset** pose variable. This variable contains the pose offset between the original saved snapshot position and the one used in the program .

Info

Please note that the arguments of the **snapshot_position_offset** parameter are expressed in the robot base reference frame.

The example shows a program using a Camera Locate node to manage parts in stacked trays.

- The script command in the BeforeStart section allows the camera not to be in the exact snapshot position when entering a Camera Locate node.
- The pose at which the robot enters the Camera Locate node is calculated knowing how many trays are stacked.
- The **snapshot_position_offset** is calculated accordingly in order for the Wrist Camera to consider the pose offset from the original snapshot position.

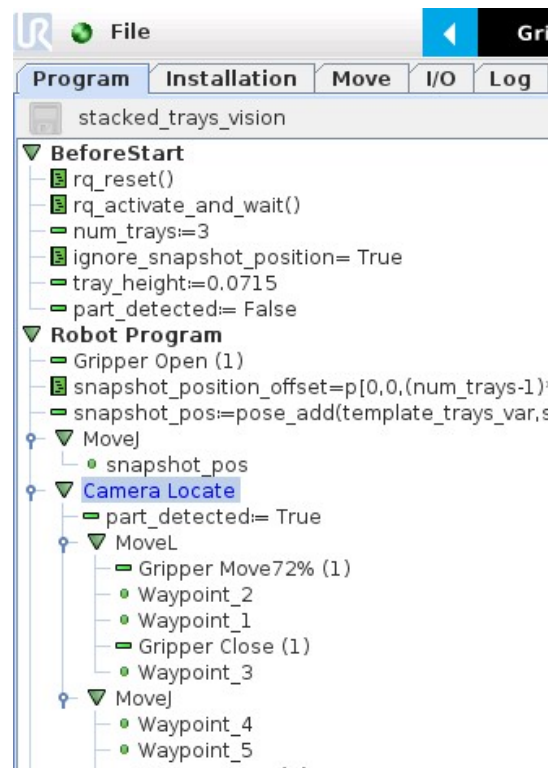

Fig. 6-7: Program example.

`ignore_snapshot_position = True`

When using this method, make sure the workplane has the same orientation and distance regarding the position of the camera before a Camera Locate node. Using a variable and relative snapshot position may decrease the precision, as the workplane can be slightly different depending on where the calibration has been performed. Be aware of this when programming a Camera Locate node relative to another one.

7. Specifications

Caution

The following manual uses the metric system, unless specified, **all dimensions are in millimeters.**

The following sub-sections provide data on the various specifications for the Robotiq 2-Finger 85 and 140 Adaptive Grippers.

- Section 7.1 mechanical specifications of the Wrist Camera:
 - Dimensions;
 - Maximum load;
 - Center of mass;
 - Moment of inertia.

- Section 7.2 electrical rating & performance specifications of the Wrist Camera:
 - Electrical supply;
 - Resolution;
 - FPS.

- Section 7.3 Vision System specifications:
 - Field of view;
 - Part size.

7.1. Mechanical Specifications of Wrist Camera

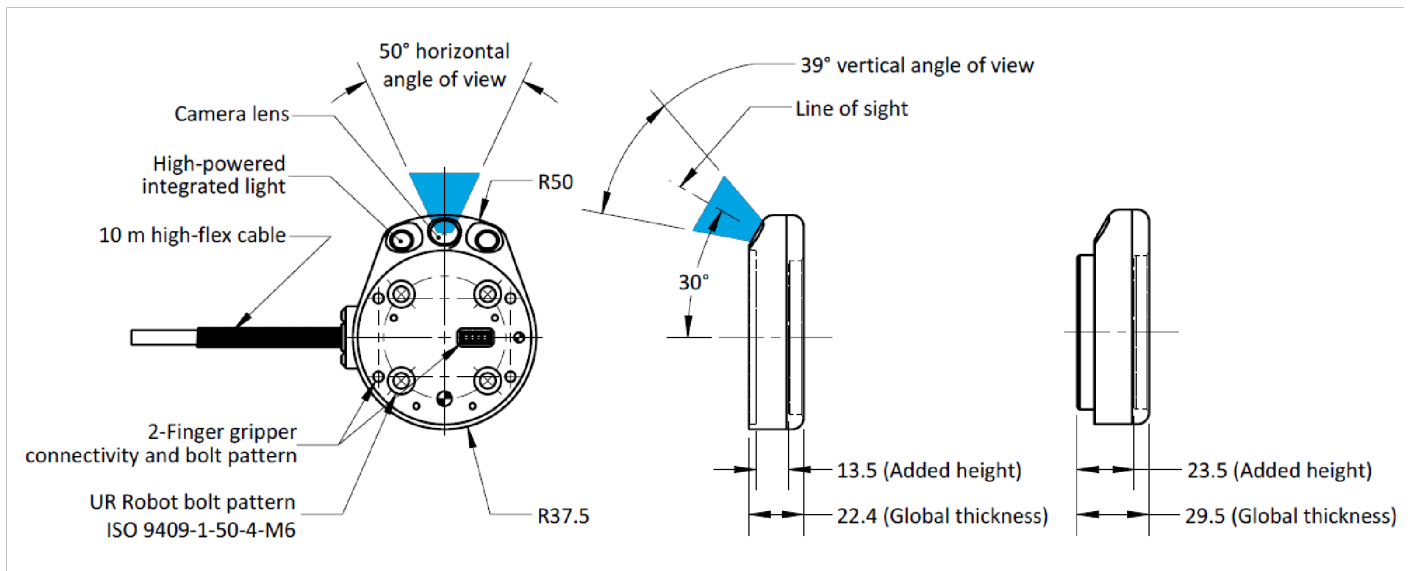

Fig. 7-1: Wrist Camera's dimensions.

Specification	Value	
Maximum load	10 kg	40 Nm
Weight (without tool plate)	160 g	
Weight (with tool plate)	230 g	
Added height (without tool plate, for use with 2-Finger Gripper)	13.5 mm	
Global thickness (without tool plate)	22.4 mm	
Added height (with tool plate)	23.5 mm	
Global thickness (with tool plate)	29.5 mm	

Wrist Camera's mechanical specifications.

Photographic sensor

Respecting Universal Robots's axes system, the photographic sensor's is located at [0mm; 35.7mm; -0.1mm] of the tool flange on which the camera is mounted. The line of sight passes through this point and is at 30° from the Z-axis.

7.1.1. Center of Mass and Moment of Inertia

The coordinate system used to calculate the moment of inertia and center of mass of the Wrist Camera is the base of the Camera which correspond to the UR tool flange reference [0,0,0].

Here is the approximate position for the center of mass. It has been calculated for the camera itself and for combinations with other Robotiq products. The camera's tool plate is included when the gripper is not mounted on the Wrist Camera.

Combination	x (mm)	y (mm)	z (mm)	Mass (grams)
-	0	5	9	230
FT 300	0	2	30	530
2-Finger 85	0	1	58	975
2-Finger 140	0	1	66	1040
FT 300 and 2-Finger 85	0	1	77	1275
FT 300 and 2-Finger 140	0	1	85	1340

Here is the approximate moment of inertia matrix for the Wrist Camera:

Inertia Matrix			Metric value (kg * mm ²)			Imperial value (lb * in ²)		
lxx	lxy	lxz	111	0	0	0.38	0	0
lyx	lyy	lyz	0	70	3	0	0.24	0.01
lzx	lzy	lzz	0	3	165	0	0.01	0.56

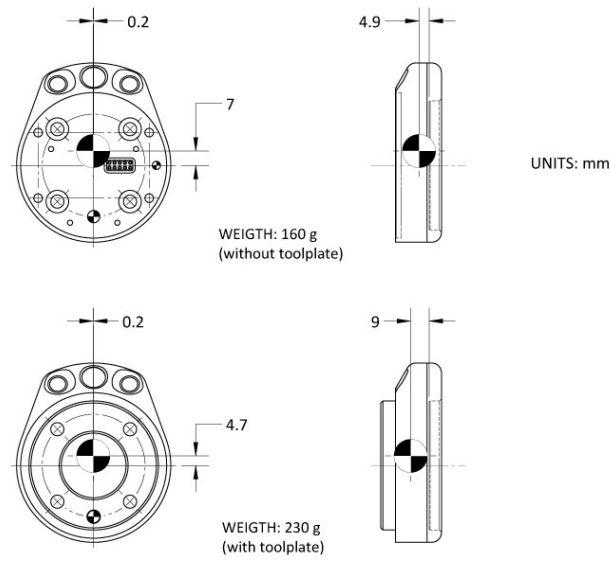

Fig. 7-2: Center of Mass with and without the toolplate.

7.2. Electrical rating & performance of Wrist Camera

Robotiq recommends you supply the Wrist Camera from the Universal Robots controller power supply as shown in the [Electrical Setup section](#); if for any reasons you cannot do so, here are the electrical specifications of the Camera:

Specification	Value
Operating supply voltage	24 V DC ±20%
Quiescent power (minimum power consumption)	1 W
Maximum power	22 W
Communication interface	USB 2.0

Here are the Wrist Camera's specifications:

Specification	Value
Maximum resolution	5 Mpx at 2 fps (2560 X 1920)
Maximum frame rate	30 fps at 0.3 Mpx (640 X 480)
Active array size	2592 X 1944
Focus range	70 mm to infinity
Integrated lighting	6 LED diffuse white light
Autofocus technology	Liquid lense

7.3. Vision System Specifications

Accuracy

The accuracy of the vision system is as described in the table below and depends on the robot model used. It is valid for the area where the calibration board was located during the calibration process.

Robot Model	Accuracy
UR3	+/- 2mm
UR5	+/- 3mm
UR10	+/- 3mm

Fig. 7-3: Accuracy of the vision system.

Calibration board position

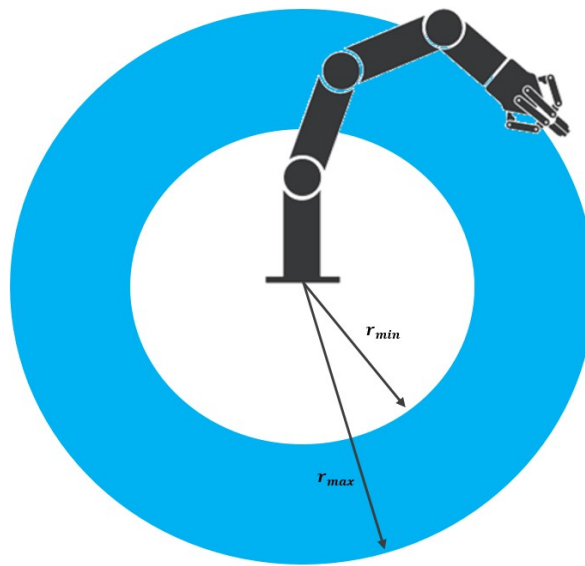

Fig. 7-4: Calibration board position.

Specification	Value		
	UR3	UR5	UR10
Minimum board distance (cm)	26	34	42
Maximum board distance (cm)	42	70	98

Tips

Snapshot Position will determine the field of view, notice that the calibration step position does not have to be the same as Snapshot position. Thus, you can have a small field of view, then move back for calibration step.

Field of view

Specification	Value		
	UR3	UR5	UR10
Maximum board distance (cm)	36 x 27	64 x 48	100 x 75
Minimum board distance (cm)	10 x 7.5	10 x 7.5	10 x 7.5

Info

Field of view is (FoV) determined by Snapshot position. To get the minimum FoV, the camera must be placed at 7 cm above the work plane.

Part dimensions

The maximum part size that can be detected by the Wrist Camera is 60% field of view's dimension. The minimum is 10%, no matter the robot or the field of view size.

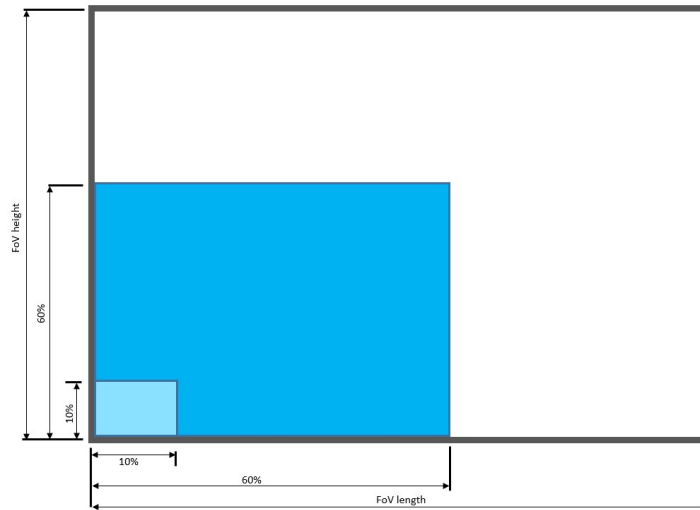

Fig. 7-5: Maximum and minimum part size.

The part must not be higher than its smallest dimension (width or length) : maximum of 1:1 ratio.

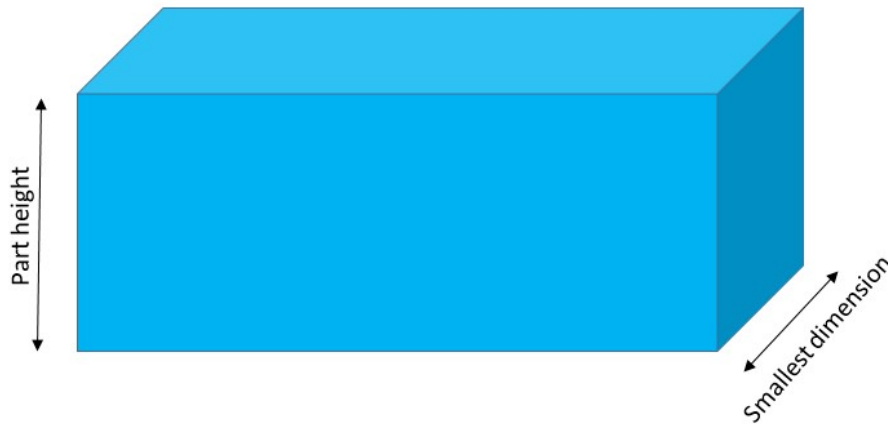

Fig. 7-6: Maximum part height.

Info

Part height ratio is taken between the maximum part height at any point and the minimum dimension present on part contour, width or length.

Background contrast

To ensure a good model and part detection from the Vision system, you should use a background that has a high color contrast with the part to be detected. You must choose colors that are apart horizontally on the HSV cone shown below. Therefore, a change in value (intensity) only does not represent a good contrast. There has to be a great difference in hue and saturation to obtain a good object model from the object teaching wizard. You can use either the yellow or pink side of the colored background provided with the camera kit. If required, use a different colored background to teach your part.

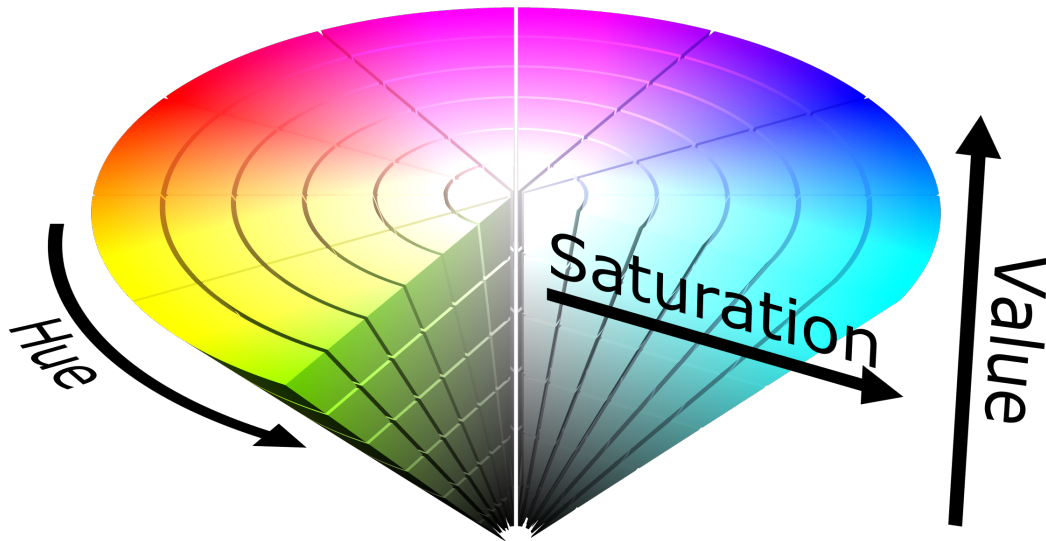

Fig. 7-7: HSV color cone.

8. Maintenance

Wrist Camera maintenance

The Camera does not need any maintenance. Make sure that the lens is kept free from liquid or dust at all time. Robotiq recommends you use the provided bag with your camera along with alcohol to clean the lens.

Clean background

You workplane should be kept as constant as possible. Depending on your application, you should occasionally clean the workplane.

Note

If your workplane background changes after the object teaching process (at runtime), object localization performance could decrease.

Tip

The Vision System is able to compensate for some differences during runtime. Adjust the detection threshold as explained in the [Detection thresholds and scores section](#) to have a reliable object localization.

9. Spare Parts, Kits and Accessories

Spare parts, kits and accessories list:

The following list is up to date at print time and is subject to change. Check online for updates.

Info

Unless specified, screws, dowel pins and other hardware are included only for the Sensor side, never for the robot side.

Item	Ordering Number
Wrist Camera Kit for Universal Robots. Includes Wrist Camera, calibration board, tool plate for UR, USB memory stick, license and hub and all hardware.	RWC-UR-KIT
Replacement Wrist Camera. Includes 10 m pigtail cable.	RWC-CAM-001
Wrist Camera tool plate for ISO 9409-1-50-4M6 pattern (Universal Robots).	RWC-TOOL-062
Replacement calibration board.	ACC-CALIB-BOARD
Replacement 10m High-Flex pigtail cable for Wrist Camera.	CBL-COM-2069-10-HF
4-port USB 2.0 hub splitter	ACC-USB-4-HUB
16 Gb USB stick	ACC-USB-16G
Replacement software license USB dongle for Wrist Camera	ACC-USB-DONGLE
Universal Robots Screw Kit for Wrist Camera	ACC-SCREW-KIT-RWC-UR

10. Troubleshooting

Info

To view the Vision server, Camera URCap and Camera firmware versions, proceed with the following:

- From a Robot program, go in the Installation tab.
- Choose Camera
- Go in the About tab.

The versions will appear. Make sure they are the latest release and that they are all updated simultaneously.

10.1. LED status

LED status	Description	Solutions
Off	The Camera is not powered.	Check the Camera's power supply and electrical setup (please refer to the Electrical Setup section).
Solid red	No fault but the Camera is not communicating.	<p>Start or do a stop/start cycle of the Vision server.</p> <p>To do so, go in the Installation tab, choose Camera and then the Camera tab.</p> <p>Click on Start camera to start the Vision server.</p> <p>The output image will appear and the LED will turn blue.</p> <p>Check the USB cable connection and the software package versions.</p>
Solid blue and red at the same time	The Camera is in fault or booting.	<p>Wait for the booting process to be completed.</p> <p>If the LED stays solid blue and red, disconnect the Camera's USB cable and power cycle it.</p> <p>The red LED should be solid red. Reconnect the USB cable.</p> <p>The LED should turn solid blue when communication is established with the Vision server (click on Start camera from the Installation tab).</p>
Blinking blue and red	Major fault: <ul style="list-style-type: none"> • Camera's input voltage is not sufficient • Temperature is greater than 70°C 	<ul style="list-style-type: none"> • Check the power supply to make sure it is 24 V DC +/- 10%. • The Wrist Camera should not operate at a temperature higher than 50°C.
Solid blue	Not fault and communicating.	-

11. Warranty and Patent

Robotiq warrants the Wrist Camera and Vision System against defects in material and workmanship for a period of one year from the date of reception when utilized as intended. Robotiq also warrants that this equipment will meet applicable specifications under normal use.

Warranty applies under the following conditions:

- Usage respects the operating and storage conditions specified in the [Environmental and Operating Conditions section](#).
- Proper installation of the Camera specified in the [Installation section](#) and the following subsections.
- Usage under normal one-shift operation (40 h a week)
- Usage respects maintenance specified in the [Maintenance section](#).
- Usage respects recommended payload and forces specified in the [Mechanical Specifications of Wrist Camera section](#).

During the warranty period, Robotiq will repair or replace any defective Wrist Camera, as well as verify and adjust the Camera free of charge if the equipment should need to be repaired or if the original adjustment is erroneous. If the equipment is sent back for verification during the warranty period and found to meet all published specifications, Robotiq will charge standard verification fees.

The unit is considered defective when at least one of the following conditions occurs :

- The Camera does not output any image;
- The Camera feedback necessary for the robot program is not accessible;
- The Vision System USB memory, USB hub or USB dongle are inoperable;

Caution

The warranty will become null and void if the :

- Unit has been tampered with, repaired or worked on by unauthorized individuals.
- Warranty sticker has been removed.
- Screws, other than as explained in this guide, have been removed.
- Unit has been opened.
- Unit serial number has been altered, erased, or removed.
- Unit has been misused, neglected, or damaged by accident.

This warranty is in lieu of all other warranties expressed, implied, or statutory, including, but not limited to, the implied warranties of merchantability and fitness for a particular purpose. In no event shall Robotiq be liable for special, incidental, or consequential damages.

Robotiq shall not be liable for damages resulting from the use of the Robotiq Wrist Camera or Robotiq Vision System, nor shall Robotiq be responsible for any failure in the performance of other items to which the Wrist Camera is connected or the operation of any system of which the Vision System may be a part.

Exclusions

This warranty excludes failure resulting from: improper use or installation, normal wear and tear, accident, abuse, neglect, fire, water, lightning or other acts of nature, causes external to the Wrist Camera, the Vision System or other factors beyond Robotiq's control.

Robotiq reserves the right to make changes in the design or construction of any of its products at any time without incurring any obligation to make any changes whatsoever on units already purchased.

12. Contact

www.robotiq.com

Contact Us

Phone

1-888-ROBOTIQ (762-6847)
(+1) 418-380-2788 Outside US and Canada

Fax

1-418-800-0046

Technical Support and Engineering

extension 3

Sales

extension 2

Head office

Robotiq:
966, chemin Olivier
Suite 500
Lévis, Québec
G7A 2N1
Canada



Where automation Pros come to share their know-how and get answers.

dof.robotiq.com

A. Harmonized Standards, Declarations and Certificates

A1. Declaration of Incorporation



Translation of Original Declaration of Incorporation

In terms of the Directive 2006/42/EC, Annex II, part B of the European Parliament and of the Council on machinery, we, the manufacturer,

Robotiq Inc.
966, Chemin Olivier, suite 325
Lévis, Québec, Canada, G7A 2N1

hereby declare that the following product:

Robotiq Vision System

meets the applicable requirements of the **Machinery Directive 2006/42/EC** of the European Parliament and of the Council. The incomplete machine may not be operated until the machine in which it is integrated is declared compliant with the relevant provisions of the 2006/42/CE Machinery Directive.

The manufacturer agrees to forward, upon request of national competent authorities, the relevant technical documents specified by Annex VII, part B, within the prescribed time.

Additionally, the product declares in conformity with the following directives, according to which the product is CE marked:

2014/30/EU	Electromagnetic Compatibility Directive (EMC)
2011/65/EU	Restriction of the use of certain hazardous substances (RoHS)

Person responsible for documentation: Annick Mottard, Jr. Eng., address: see manufacturer address

Lévis, November 2017



Jean-Philippe Jobin
Vice President Research and Development

Robotiq Inc.

The following standards have been applied:

NF EN ISO 12100	2010	Safety of machinery — General principles for design — Risk assessment and risk reduction
CEI 60204-1 Ed6.0	2016	Safety of machinery — Electrical equipment of machines — Part 1: General requirements

A2. Ingress Protection Certificate



October 12th 2018

Purpose: Ingress Protection (IP67) – Wrist Camera Test Certificate

To whom it may concern,

This certificate is to attest that Ingress Protection (IP) tests were carried out by NTS Canada in the months of June and July 2018 on Wrist Cameras manufactured by Robotiq. No ingress of dust or water was observed inside the units after the tests. No insertion of the rod or induced damage was observed. No functional anomaly was noticed or reported by the Robotiq engineering representative on-site during the tests. This test certificate does not supersede the test report FTR0201898 Rev 00 issued by NTS Canada.

The acceptance status for the units tested is "PASS" for the following tests;

- Ingress protection against access to hazardous parts – Rod (code IP6X)
- Ingress protection against solid foreign objects - Dust (code IP6X)
- Ingress protection against immersion in water (code IPX7)

Sincerely yours,

Jean-Pierre
Rioux

Digitally signed by Jean-Pierre
Rioux
DN: cn=Jean-Pierre Rioux, o,
ou=NTS Canada Inc.,
email=Jean-
Pierre.Rioux@NTS.com, c=CA
Date: 2018.10.12 11:32:13
-0400'

Jean-Pierre Rioux, P. Eng.
Lab Manager
National Technical Systems Canada inc.
2425 Industrial Blvd
Chambly, Quebec
J3L 4W3 Canada